

ORTAL®

YOUR LIFE. YOUR FIRE.

Installation and Operation Manual -Built-in Models-

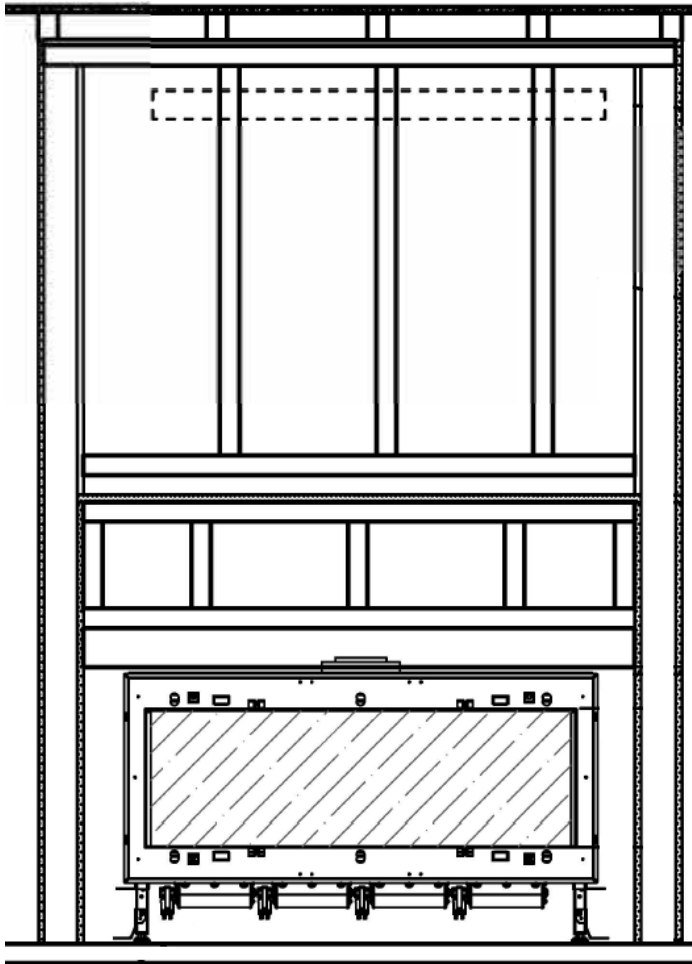

Manufacturer Update – Installation Manual Update

Manufacturer Effective Date: September 19th, 2018
Serial Number 16050 and forward

▲ WARNING:
FIRE OR EXPLOSION HAZARD
Failure to follow safety warnings exactly could result in serious injury, death, or property damage.

- **DO NOT** store or use gasoline or other flammable vapors and liquids in the vicinity of this or any other appliance.
- **What to do if you smell gas**
 - **DO NOT** try to light any appliance.
 - **DO NOT** touch any electrical switch. **DO NOT** use any phone in your building.
 - Leave the building immediately.
 - Immediately call your gas supplier from a neighbor's phone. Follow the gas supplier's instructions.
 - If you cannot reach your gas supplier, call the fire department.
- Installation and service must be performed by a qualified installer, service agency, or the gas supplier.

Built-in Models:

Front Facing Series
Traditional Series
Corner (RS/LS) Series
Tunnel Series
Three Side Series
Space Creator Series

! DANGER



**HOT GLASS WILL
CAUSE BURNS.**

**DO NOT TOUCH GLASS
UNTIL COOLED.**

**NEVER ALLOW CHILDREN
TO TOUCH GLASS.**

A barrier designed to reduce the risk of burns from the hot viewing glass is provided with this appliance and shall be installed for the protection of children and other at-risk individuals.

Fireplace Safety Information and Warnings

This section provides safety guidelines and instructions. It is important to **SAVE THESE INSTRUCTIONS** and to make yourself fully aware of all the safety protocols and the many features of the ORTAL direct vent gas fireplace appliance. ALL warnings and instructions below apply to all products manufactured and distributed by ORTAL.



WARNING – HEAT BARRIER

A barrier designed to reduce the risk of burns from hot viewing glass is provided with this appliance and shall be installed.

Appliance **MUST** not be used without the heat barrier in place.

If the barrier becomes damaged, the barrier shall be replaced with the manufacturer's barrier for this appliance.

Any safety screen, guard, or barrier removed for servicing the appliance must be replaced prior to operating.



WARNING – FIREPLACE TEMPERATURE

Due to hot temperatures, the appliance should be located out of traffic and away from furniture and draperies.

Children and adults should be alerted to the hazards of high surface temperature and should stay away to avoid burns or clothing ignition.

Clothing or other flammable material should not be placed on or near the appliance.

Young children should be carefully supervised when they are in the same room as the appliance.

Toddlers, young children and others may be susceptible to accidental contact burns. A physical barrier is recommended if there are at-risk individuals in the house. To restrict access to a fireplace or stove, install an adjustable safety gate to keep toddlers, young children and other at-risk individuals out of the room and away from hot surfaces.



WARNING – GLASS HANDLING

The glass must **ONLY** be removed by an authorized and/or qualified installer. The authorized technician should **ONLY** remove the glass with the suction cups supplied by the manufacturer. To prevent damage to the glass edges, lower the glass to rest in a safe place.

Follow these guidelines for glass handling:

Step 1: Prepare a safe place for the glass to rest.

Step 2: Remove the glass using the suction cup.

Step 3: The glass can now be rested safely.



WARNING – INSTALLATION AND OPERATION

The direct vent system appliance must be installed as an OEM installation in manufactured homes (USA only) or an aftermarket permanently located, or a mobile home, where not prohibited by local codes.

The appliance must be installed in accordance with the Manufacturer's instructions and the Manufactured Home Construction and Safety Standard, Title 24 CFR, Part 3280, in the United States, or the Standard for Installation in Mobile Homes, CAN/CSA Z240 MH Series, in Canada.

If the information in these instructions are not followed exactly, a fire or explosion may result, causing property damage, personal injury or loss of life.

Do not store or use gasoline or other flammable vapors and liquids near this appliance.

 **WARNING – INSTALLATION AND SERVICE**

Installation and repairs must be done by an authorized qualified installer service agency or gas supplier. The appliance should be inspected before use and at least annually by a professional service person. More frequent cleaning may be required due to excessive lint from carpeting, bedding material, etc. It is imperative that control compartments, burners and circulating air passageways of the appliance be kept clean.

Any alteration to the product can cause soot or carbon to form and may result in damage. This damage and any other damage that results from not following the instructions outlined in this manual is not the responsibility of the manufacturer.

 **WARNING – ELECTRICAL GROUNDING**

These Direct Vent appliances must be electrically grounded in accordance with the local codes or, in the absence of local codes, with National Electric code, ANSI/NFPA 70, or the Canadian Electric Code, CSA C22.1.

 **WARNING – GAS APPLIANCE**

This appliance is for use only with the type of gas indicated on the rating plate. These appliances are not convertible for use with other gases unless a certified kit is used and the conversion is performed by an authorized and qualified technician.

Applicable standards are Vented Gas Fireplace Heaters ANSI Z21.88 / CSA 2.33a and Gas-fired Appliances for Use at High Altitudes CAN/CGA 2.17-M91.

Table of Contents

Fireplace Safety Information and Warnings	2
Certifications and Codes	7
Product List: Built-In ORTAL Models and Burners	8
Fireplace Building Requirements	9
Non-combustible material	9
Framing and Drywall	9
Heat Release	9
Heat Release: Reveal or Gap	10
Heat Release: Ventilation Grill (aka Louver).....	11
Vertical Heat Release Designs	12
Sprinkler Clearance to Heat Release	15
Air Intake.....	15
Fireplace Legs.....	15
Access Panel.....	16
Double Glass Requirements	17
Power Requirements	17
Air Intake Requirements	17
Air Intake for a Platform	18
Framing Diagrams.....	19
Front (F) & Traditional (TR) Series Framing Diagram	20
Corner (RS/LS) Series Framing Diagram	21
Tunnel (TN) Framing Diagram	22
Three Side (TS) Framing Diagram.....	23
Clearance & Finish Diagrams	25
General Clearance Requirements	25
Minimum Firebox Clearances Diagram	27
Clearance to Furniture & Other Combustibles	28
Inside Corner Clearances	28
Television/Art Installation Information & Diagrams	29
TV and Art Mounting Requirements	29
Finish Diagrams	32
Non-Combustible (Stone) Finish.....	32
Non-Combustible (Stone) Finish with Non-combustible Hearth Extension	33
Brick Veneer Finish	34
Recessed Combustible (Wood) Finish	35
Flush Combustible (Wood) Finish	36
Wood Hearth Extension	37
Mantel Diagrams.....	38
Mantel Detail for a Recess and Flush Application	38
Mantel Detail for Traditional Series	39
Ledge (Shelf) Detail	40
Chase Area Minimums	41

Diagram for Structural Weight Support	42
Gas Requirements and Setup	43
Routing the Gas Line	43
Routing the Gas Line for Traditional Series.....	44
Gas Pressure and Heat Input Charts	45
High Altitude Gas Requirement	45
Gas Control Assemblies and Components	46
Gas Conversion	46
Pilot Inspection	47
Pilot Maintenance	47
Thermocouple Maintenance.....	47
Electrical Guidelines	48
Electrical Requirements	48
Electrical Requirements for Traditional Series.....	48
Wiring Diagrams.....	48
Screen Unit	48
Screen Unit with Lights.....	49
Screen Unit with ORTAL Power Vent.....	49
Screen Unit with ORTAL Power Vent and Lights	50
Screen Unit with Energex Power Vent	51
Double Glass Unit	52
Double Glass Unit with Lights.....	53
Double Glass Unit with ORTAL Power Vent.....	54
Double Glass Unit with ORTAL Power Vent and Lights	54
Double Glass Unit with Energex Power Vent	55
Safety Box Detail: Double Glass Unit without Lights	56
Safety Box Detail: Double Glass Units with Lights	56
Smart Home System Wiring Information	57
Vent System Information.....	58
General Pipe Requirements & Certified Pipe Manufacturers	58
Venting Installation and Clearances.....	58
Vent Pipe Clearances.....	59
Venting Diagrams.....	59
Offset (bends/elbows) Maximums	59
Horizontal Termination Venting Run Diagram	60
Vertical Termination Venting Run Diagram.....	61
Vertical Termination Venting Run Diagram – Straight Vertical	62
Vent Restrictor Sizing Guidelines	62
Fireplace Restrictors and Vent Arrangement.....	64
Restrictor Table: Series 40 (Burner 30)	64
Restrictor Table: Series 75 (Burner 45)	64
Restrictor Table: Series 110/130 (Burner 100).....	65
Restrictor Table: Series 150/170 (Burner 135).....	65
Restrictor Table: Series 200 (Burner 160)	65

Restrictor Table: Series 250 (Burner 180)	65
Horizontal Termination Clearance Diagrams	66
Vertical Termination Clearance Diagrams	67
Chimney Shroud Detail	68
Vent Maintenance	69
Fireplace Cavity (Chase) Construction	69
Cavity (Chase) Construction Notes.....	70
Fireplace Installation Instructions	71
Selecting a Location	71
Installation Sequence	72
First Trip to Site: Planning Phase	72
Second Trip to Site: Installation Phase	72
Third Trip to Site: Startup Phase	72
Working with Glass Panels	73
Remote Control Setup and Operation	74
Remote Control Radio Frequency	74
Pairing Remote to Receiver (Setting the Electronics Code)	75
Battery Requirements	75
Operating Instructions	76
Interior Design Media	77
Media Placement Guidelines	77
Cold Climate Insulation.....	80
Post-installation Procedures.....	80
Operating Warnings.....	81
Maintenance Instructions.....	81
Warranty Policy	82
Sample Product Certification Labels.....	85

Certifications and Codes

The ORTAL direct vent gas appliances have been tested and approved by CSA for safety and efficiency for use with either Natural Gas (NG) or Propane (LP), and **NOT** for use with solid fuels.

U.S. Certification Codes:

ANSI Z21.88/CSA 2.33 - Vented Gas Fireplace Heaters

ANSI Z21.50/CSA 2.22 - Decorative Vented Gas Fireplaces



Canadian Certification Codes:

CLASS 2901 84 – DOMESTIC HEATERS (GAS) Vented Fireplace – Certified to US Standard

CLASS 2901 04 – DOMESTIC HEATERS (GAS) Vented Fireplace

All ORTAL appliances, except Tunnel models, are CSA certified for indoor use **only**. Tunnel models can be specialized for indoor-outdoor use with an “Indoor-Outdoor Kit” supplied by ORTAL. For indoor installation, appliances must be installed while maintaining required clearances. ORTAL appliances are not approved for fully outdoor installation. Installation is recommended in living spaces such as bedrooms, living rooms, great rooms, etc. The appliances are not approved for closet installation.

The appliance must be installed according to ORTAL requirements in addition to any local codes that may apply, such as:

- USA: ANSI Z223.1/NFPA 54
- Canada: CSA B149

In addition:

- Consult the authority having jurisdiction to determine the need for a permit **PRIOR** to starting the installation.
- It is the responsibility of the installer to ensure that this fireplace is installed in compliance with the manufacturer's instructions and all the applicable codes.
- Before starting, take careful note of **ALL** the **WARNINGS** in this manual.

Patent Pending for screen barrier glass bracket: USSN 60/040,074

Product List: Built-In ORTAL Models and Burners

The following table lists burners and venting for models using the installation code **ANSI Z21.88/CSA 2.33** for *vented gas fireplace heaters* for which the instructions in this manual apply.

Table 1: Burner Sizes: Vented Gas Fireplace Heaters

Series	Burner	Models	Vent Pipe Size
40	30	Clear 40H70 F/RS/LS/TS/TN	4x6 co-axial direct vent pipe
75	45	Clear 60x80 F/TN Clear 75 F/RS/LS/TS/TN Space Creator 75 Clear 75x65 F/TN	4x6 co-axial direct vent pipe
110 120 130	100	Clear 110 F/RS/LS/TS/TN Clear 110H F/RS/LS/TS/TN Space Creator 120 Clear 130 F/RS/LS/TS/TN Clear 130H F/RS/LS/TS/TN	5x8 co-axial direct vent pipe
150 170	135	Clear 150 F/RS/LS/TS/Tunnel Clear 150H F/RS/LS/TS/Tunnel Space Creator 150 Clear 170 /RS/LS/TS/Tunnel Clear 170H /RS/LS/TS/Tunnel	5x8 co-axial direct vent pipe
200	160	Clear 200 F/RS/LS/TS/TN Clear 200H F/RS/LS/TS/TN Space Creator 200	5x8 co-axial direct vent pipe
250	180	Clear 250 F/RS/LS/TS/TN Clear 250H F/RS/LS/TS/TN	5x8 co-axial direct vent pipe

The following table lists burners and venting for models using the installation code **ANSI Z21.50/CSA 2.22** for *decorative vented gas fireplaces* for which the instructions in this manual apply. Decorative appliances cannot use the thermostat function.

Table 2: Burner Sizes: Decorative Vented Gas Fireplaces

Series	Burner	Models	Vent Pipe Size
Traditional	45D	Traditional 90 Traditional 110	5x8 co-axial direct vent pipe



NOTE: The 250 and Traditional series are only available for operation with natural gas.

ORTAL is certified to be used with the following direct vent pipe manufacturers:

[Olympia: Ventis line](#)

[DuraVent: Direct Vent Pro line](#)

[ICC: EXCELDirect line](#)

[BDM: Pro-Form Direct Vent System line](#)

[Selkirk: Direct-Temp System line](#)

Fireplace Building Requirements

This section provides information, diagrams and recommendations related to mounting, minimum clearances, television installation and more. These appliances are approved as long as minimum clearance to combustible materials is maintained, as shown in the diagrams provided in this chapter.

Non-combustible materials may be installed on the appliance face as long as the minimum clearances are maintained between the appliance and the non-combustible material. Surrounding material is not allowed to transfer weight to the unit or be connected in any way to the unit, with the exception of 5/8" Type X drywall (or its equivalent) in a flush install. It may be fastened to the frame with 1" self-tapping drywall screws 16" on center, with a minimum of 2 ½" from the glass lip. It must not transfer weight to the fireplace or cover any portion of the removable glass panel or the control compartment.

To ensure the safety and proper functioning of the appliance, the minimum clearances (air space) to any building materials must be adhered to, as stipulated in the diagrams and instructions contained in this manual and found on our website.

Non-combustible material

Material which will not ignite and burn. Such materials are those consisting entirely of steel, iron, brick, tile, concrete, slate, glass or plasters, or any combination thereof. Materials that are reported as passing ASTM E 136, Standard Test Method for Behavior of Materials in a Vertical Tube Furnace at 750 °C shall be considered non-combustible materials. An exception is made only for fire rated 5/8" Type X drywall UL authorized or equivalent. 5/8" Type X drywall may be used as a non-combustible material. For greater heat resistance, fireplace-specific cement boards like those produced by Promafour and Skamol are recommended in place of 5/8" Type X drywall. The use of these materials does not reduce any of the listed clearances. These materials are not being used for fire protection. They are used for high K and R value. Do not use cement boards containing Styrofoam beads.

Framing and Drywall

Fireplace chase may be framed with metal studs or wood studs. If framing with wood studs, the first 18" above the fireplace glass must be framed with steel studs. Wood framing must be covered completely with non-combustible material and have the gaps sealed with a non-combustible fire sealant. We recommend using 5/8" Type X drywall with a level 1 finish or its equivalent for the enclosure of the fireplace chase. The framing of the fireplace chase wall must be designed to carry the entire weight of the wall. Plan to include weight of other finish materials placed on the drywall.

Heat Release

A heat release is **required** for all built-in models. This allows for heat building up within the fireplace chase to be released back into the living space, helping to keep the fireplace wall cool. It must be located at the top of the fireplace chase and be placed **within** 6 inches (0-6") of the fireplace chase ceiling (aka draft stop). It can be located on the front, sides or back of the fireplace chase, as long as it is being released into an interior space. The heat release cannot be vented outdoors as this would expose the appliance to outdoor elements. A minimum air space is required per series:

Series 40-130: Minimum 124 sq. in. of free air space
Series 150-200: Minimum 200 sq. in. of free air space
Series 250: Minimum 250 sq. in. of free air space

These air space values are the minimum required; they can always be greater. The heat release can be in the form of (but not limited to) a ventilation grill (louver), gap, or reveal. If using a grill, make sure that

the net free airspace allowed in the louvered area is equal or greater than the minimum number of square inches required per unit.

The interior area of the fireplace cavity (in square inches) can never be less than your required heat release size. The area of the fireplace cavity is determined by multiplying the cavity width by the cavity depth.

Heat Release: Reveal or Gap

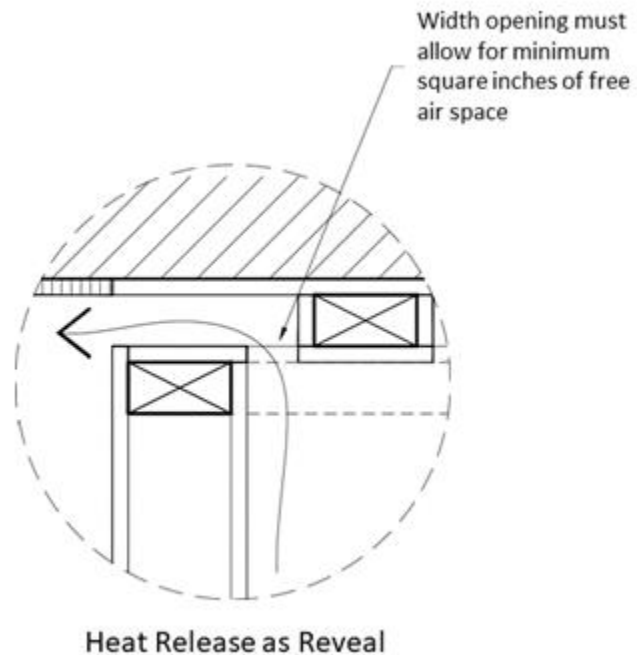
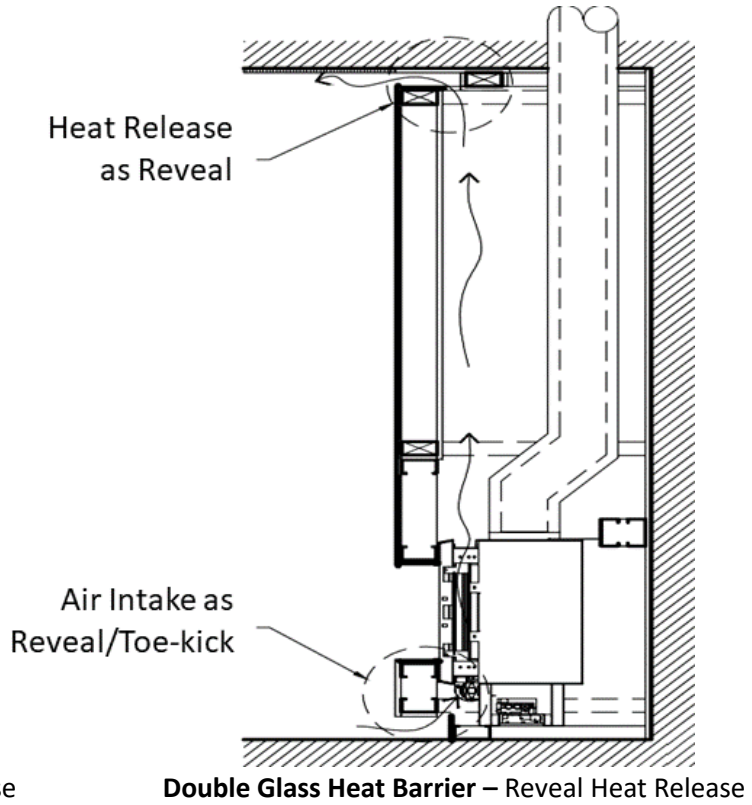
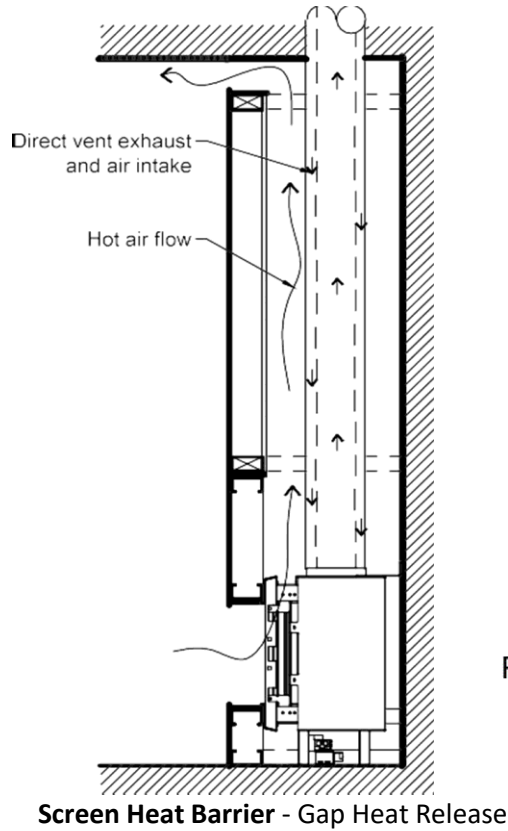

Heat Release: Ventilation Grill (aka Louver)

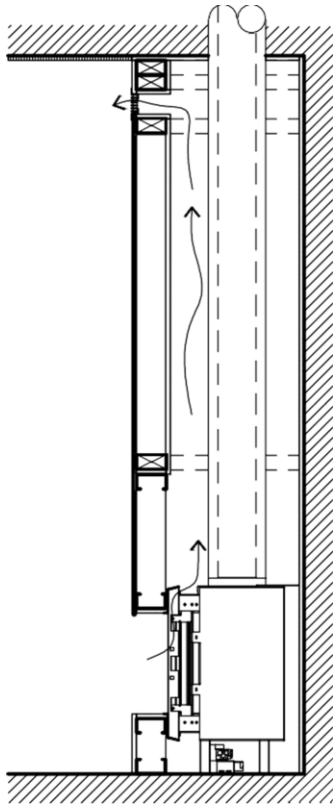

Screen Heat Barrier – Ventilation Grill (Louver)

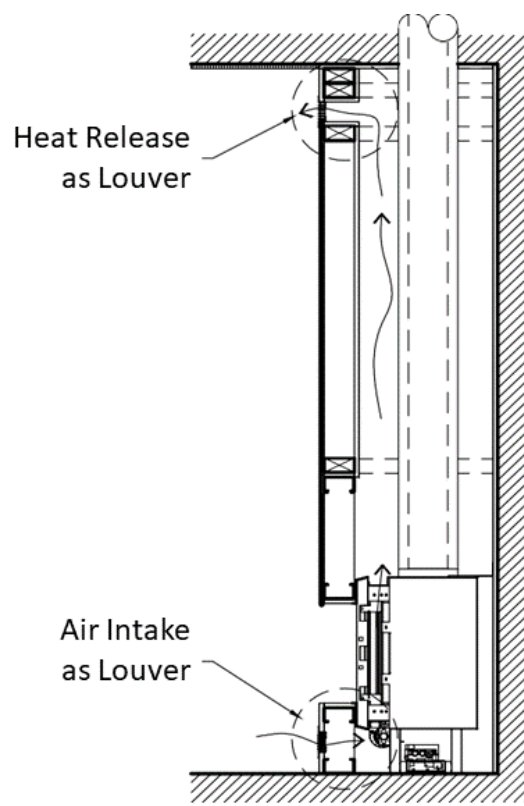

Double Glass Heat Barrier – Ventilation Grill (Louver)

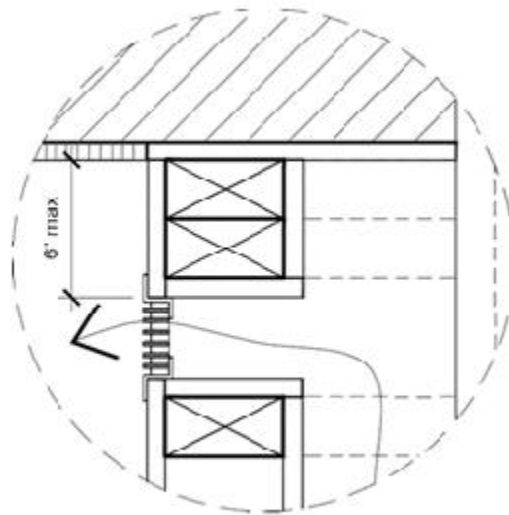

Heat Release as Louver

Vertical Heat Release Designs

If your design cannot accommodate a horizontal heat release, a vertical heat release is acceptable. Because heat rises, it will take longer for the heat to dissipate out of a vertically oriented heat release. To compensate, a vertical heat release must be 30% larger than a horizontal heat release.

Series 40-130: Minimum 160 sq. in. of free air space for a vertical heat release

Series 150-200: Minimum 260 sq. in. of free air space for a vertical heat release

Series 250: Minimum 325 sq. in. of free air space for a vertical heat release

The heat release needs to **start *within* 6 inches (0-6")** of the ceiling.

The vertical heat release can be applied using (but is not limited to) the following methods:

Front Vertical Heat Release

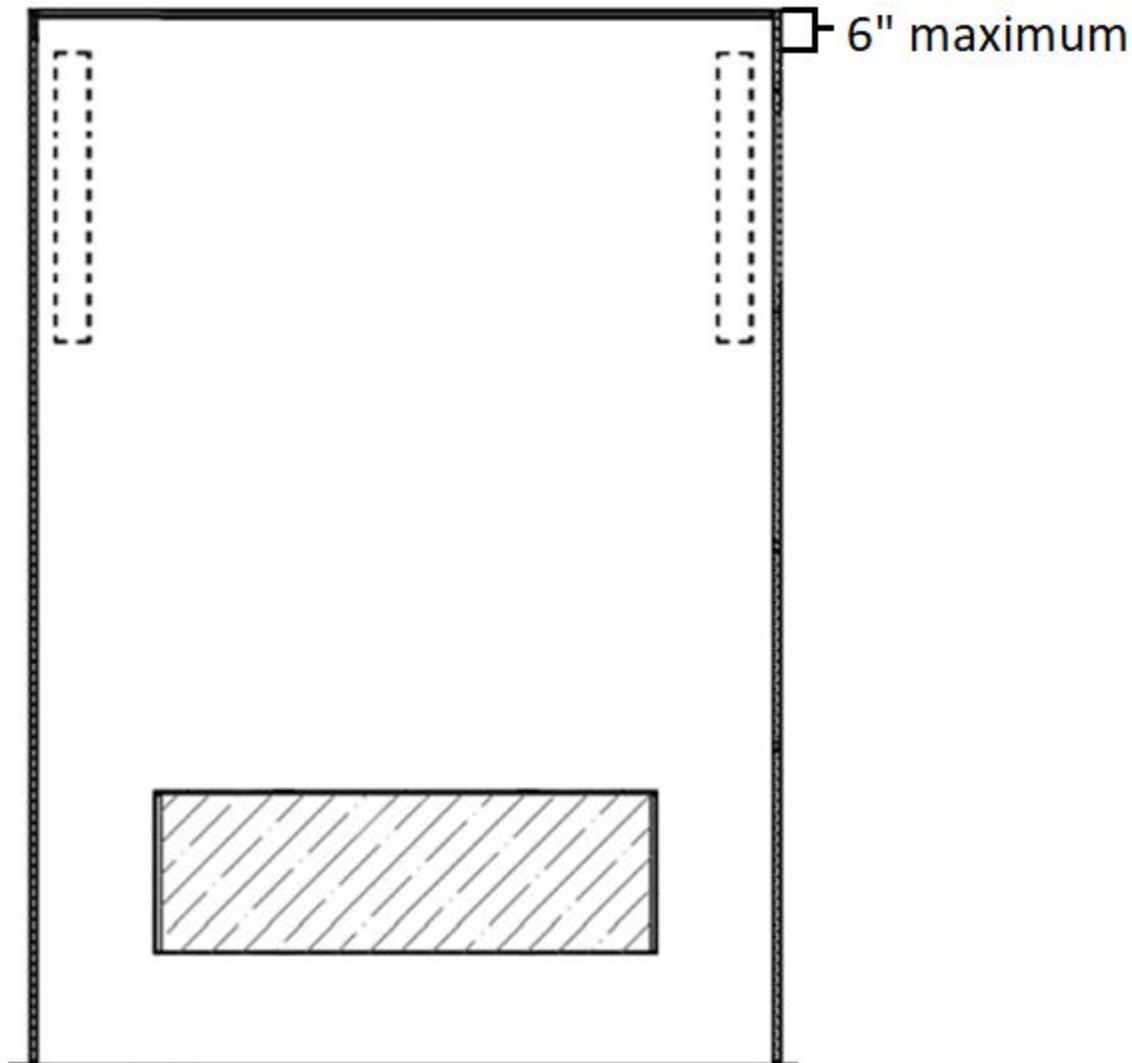

Front Vertical Heat Release (Front Elevation View)

Half Side Vertical Heat Release

Each half of the vertical heat release is put on each side of the fireplace cavity.

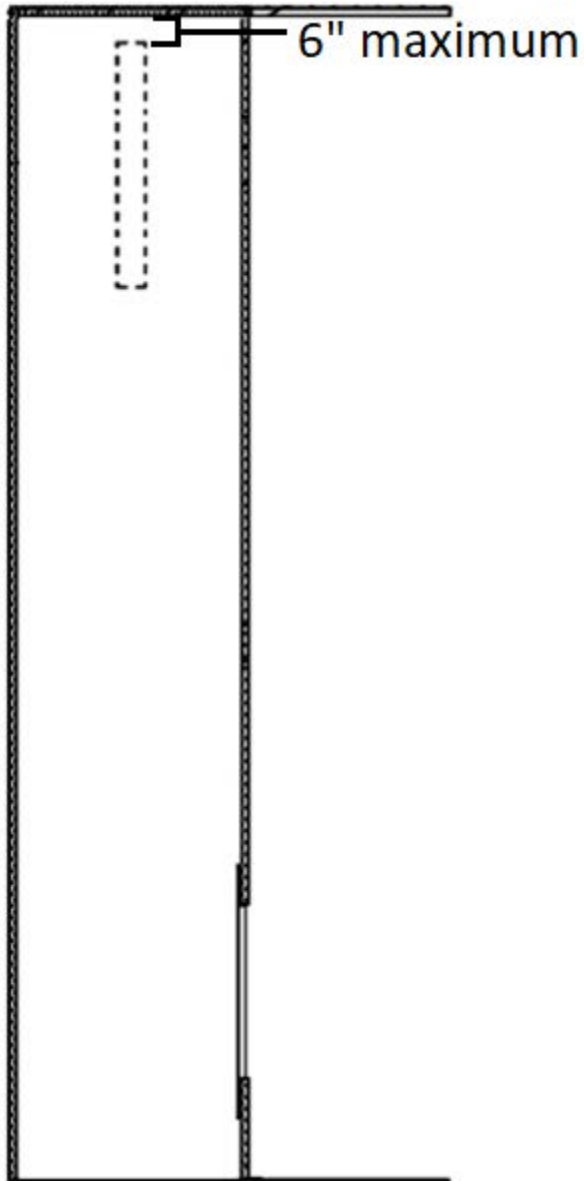

Left Side Vertical Heat Release (Side Elevation View)

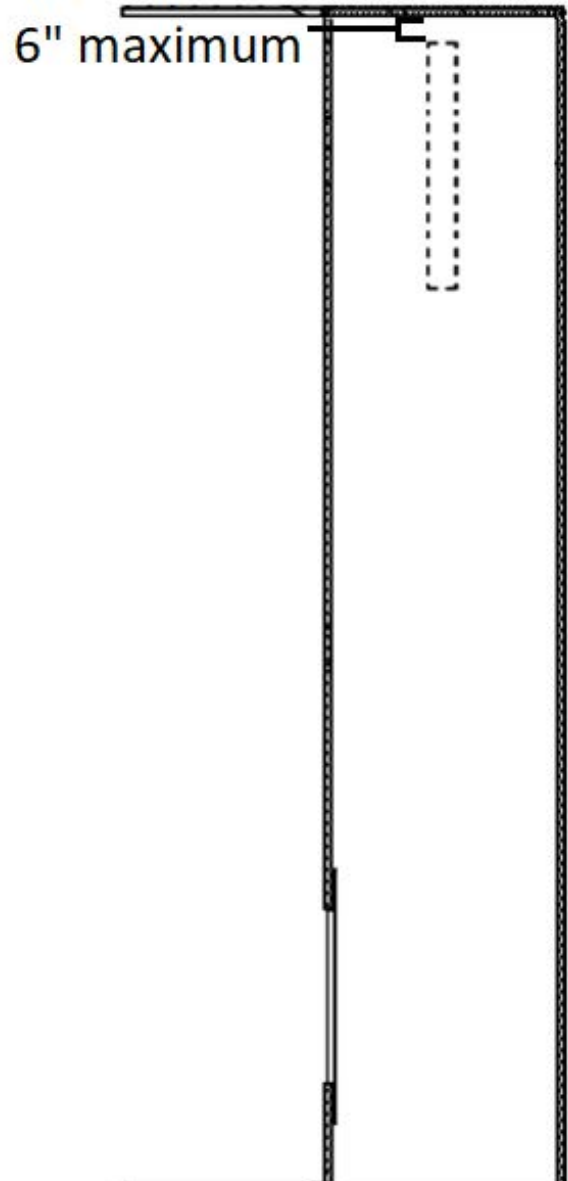

Right Side Vertical Heat Release (Side Elevation View)

Full Side Vertical Heat Release

The entire heat release is put on just one side of the fireplace cavity.

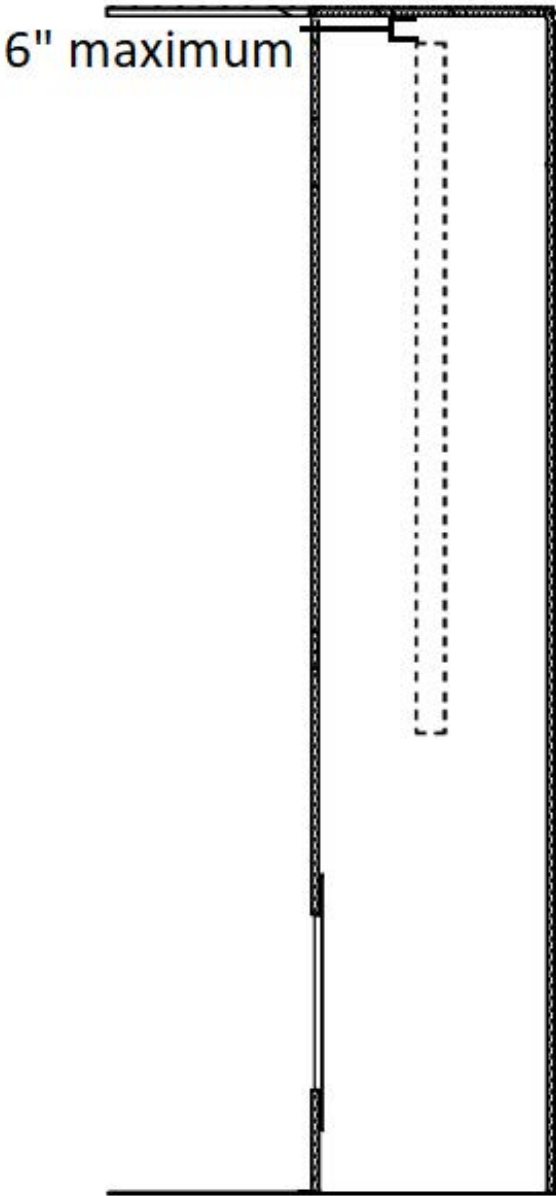

Full Side Vertical Heat Release (Right Elevation View)

Sprinkler Clearance to Heat Release

In a situation where a sprinkler head is in close proximity to the heat release, the detail shown in the diagram below **must** be followed. The distance between the sprinkler head to the heat release opening cannot be less than 60 inches (linear length) from every point of the heat release opening.

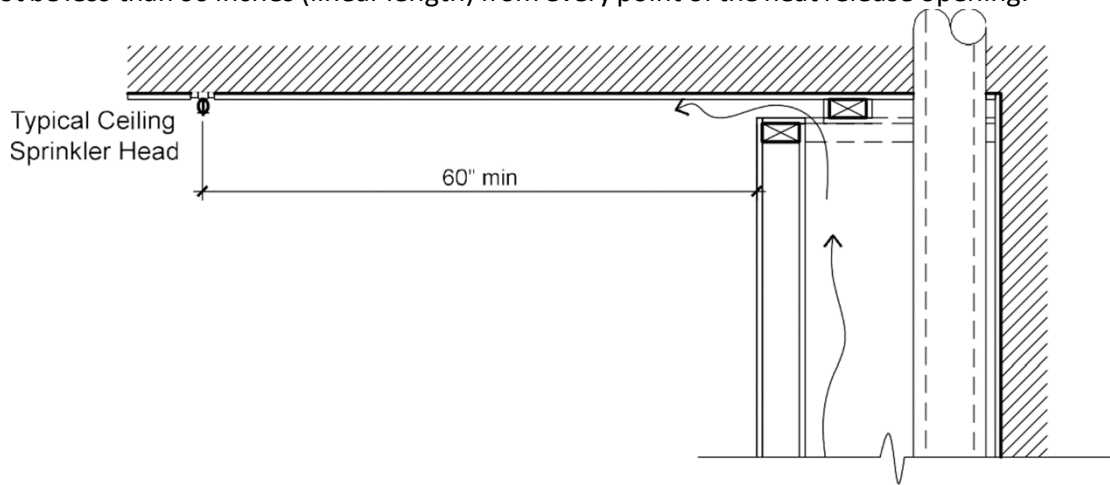

Air Intake

An air intake is only required for double glass models. The air intake must be located at or below the level of the double glass fans. This allows for fresh air to be provided to the double glass fans. See the "Double Glass Requirements" section for details.

Fireplace Legs

All ORTAL built-in fireplaces come standard with legs (with the exception of the Traditional series with a screen heat barrier, which that comes without legs). These legs ensure that there is enough air flow under the fireplace for proper operation. **The legs cannot be removed.**

All built-in units: $9 \frac{13}{16}$ " from the bottom of the fireplace glass opening to the floor.

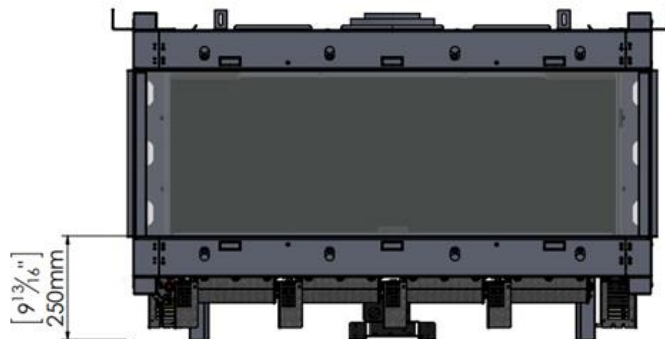

NOTE: Since March 2018 with serial #15275, leg heights have been standardized to one height regardless of heat barrier type ($9 \frac{13}{16}$ ""). For fireplaces manufactured prior to March 2018 (with a serial number smaller than 15275), the leg heights are as follows:

Double glass units: $9 \frac{13}{16}$ " from the bottom of the fireplace glass opening to the floor.

Screen units: $8 \frac{1}{4}$ " from the bottom of the fireplace glass opening to the floor.

Access Panel

An access panel is not required, but it is **highly recommended** for all built-in ORTAL appliances (except the Traditional series*). It allows for access to the appliance's gas and electrical components for servicing.

Access Panel Size and Location Recommendations:

- Minimum of 10"x10" in size
- Located within 36" of the pilot (see "Gas Requirements and Setup" for diagram)

The size and location of the access panel may vary, but in all cases, it must allow the technician to comfortably access and service the appliance's gas and electrical components. These components are attached to the pilot on a flexible gas line and can be moved to any location within 36 inches of the pilot (which is located at the center front of the burner).

For ease of access, move the appliance's gas and electrical components as close to the access panel as possible. If there is any distance between the access panel and the gas and electrical components, it is recommended to increase the size of the access panel accordingly. Prior to installation, fireplace dealers/installers should work with their clients, project architects and/or interior designers to determine the best size and location of their access panel.

If an access panel cannot be incorporated, the alternative method of servicing the gas and electrical components would be through the firebox. This procedure requires removing the glass panel(s), taking out the interior design media, and lifting the grill, burner and bottom pressure release valve. This will increase service time and difficulty. An access panel is always preferred.

Fireplace dealers/installers are advised to consult with their clients regarding the advantages and disadvantages of each service option.

***Exception:** The Traditional series has an access panel built in on the left side of the interior of the firebox and does not need an access panel incorporated into the firebox surroundings. This access panel is hidden under a removable decorative interior panel, and opens to the gas and electrical components, which have been built onto the left side of the unit. To access these components, remove heat barrier (screen or double glass), interior glass, and left decorative side panel, and access components through the access panel door. However, if a Traditional series fireplace is being power vented, a 12"x12" access panel is required for access to power vent control box under the fireplace. Please see the Ortal Power Vent Manual for details.

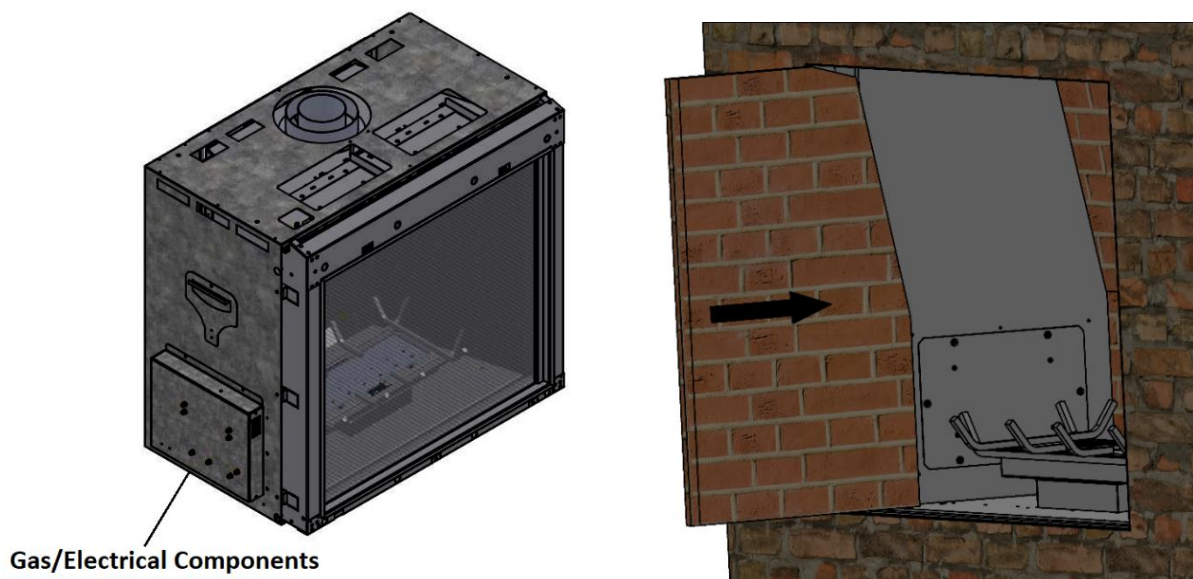

Double Glass Requirements

When installing a double glass ORTAL appliance, it is essential to maintain cool air flow between the glass panels and through the chase cavity. To maintain air flow between the glass panels and to allow cool room air to enter the chase cavity, an opening must be provided at or below the level of the double glass fans. This opening, called an air intake, needs to be made before closing the wall surface below the fireplace.

Power Requirements

Prepare a 110-volt 15-amp dedicated power line (2 gang outlet) to the access panel area (or near the burner area if an access panel isn't available) to provide power for the double glass fans that circulate cooling air between the safety barrier glass panels and up through the chase.

The following diagrams show two options for constructing the chase cavity air intake when the appliance is located on a platform. Please note that these drawings are not to scale. All fireplace drawings with correct dimensions are available on our website.

Air Intake Requirements

Each series has a minimum air intake size requirement:

- Series 40-130: Minimum 124 sq. in. of free air space
- Series 150-200: Minimum 200 sq. in. of free air space
- Series 250: Minimum 250 sq. in. of free air space

These air space values are the minimum required; they can always be greater. The air intake can be in the form of a ventilation grill (louver), gap, or toe kick. If using a grill, make sure that the *net free airspace* allowed in the louvered area is equal or greater than the minimum number of square inches required per unit.

The air intake is not required to be on the front wall of the fireplace. As long as the air intake is located at or below the level of the fans, it can be on the front, the back, or sides of the wall, or any combination thereof on an interior wall. An air intake cannot be on an exterior wall.

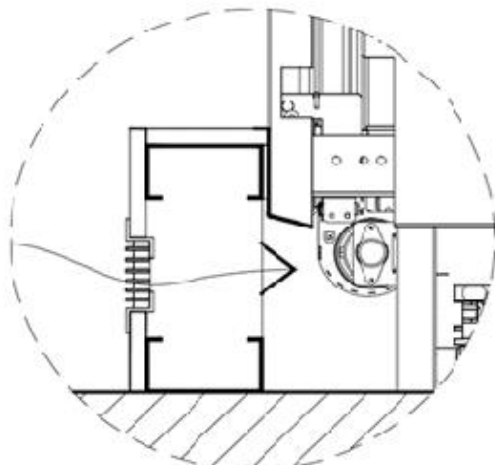

Air Intake as Louver

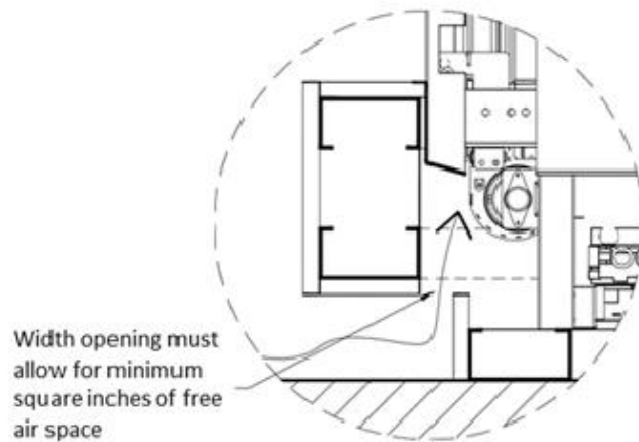



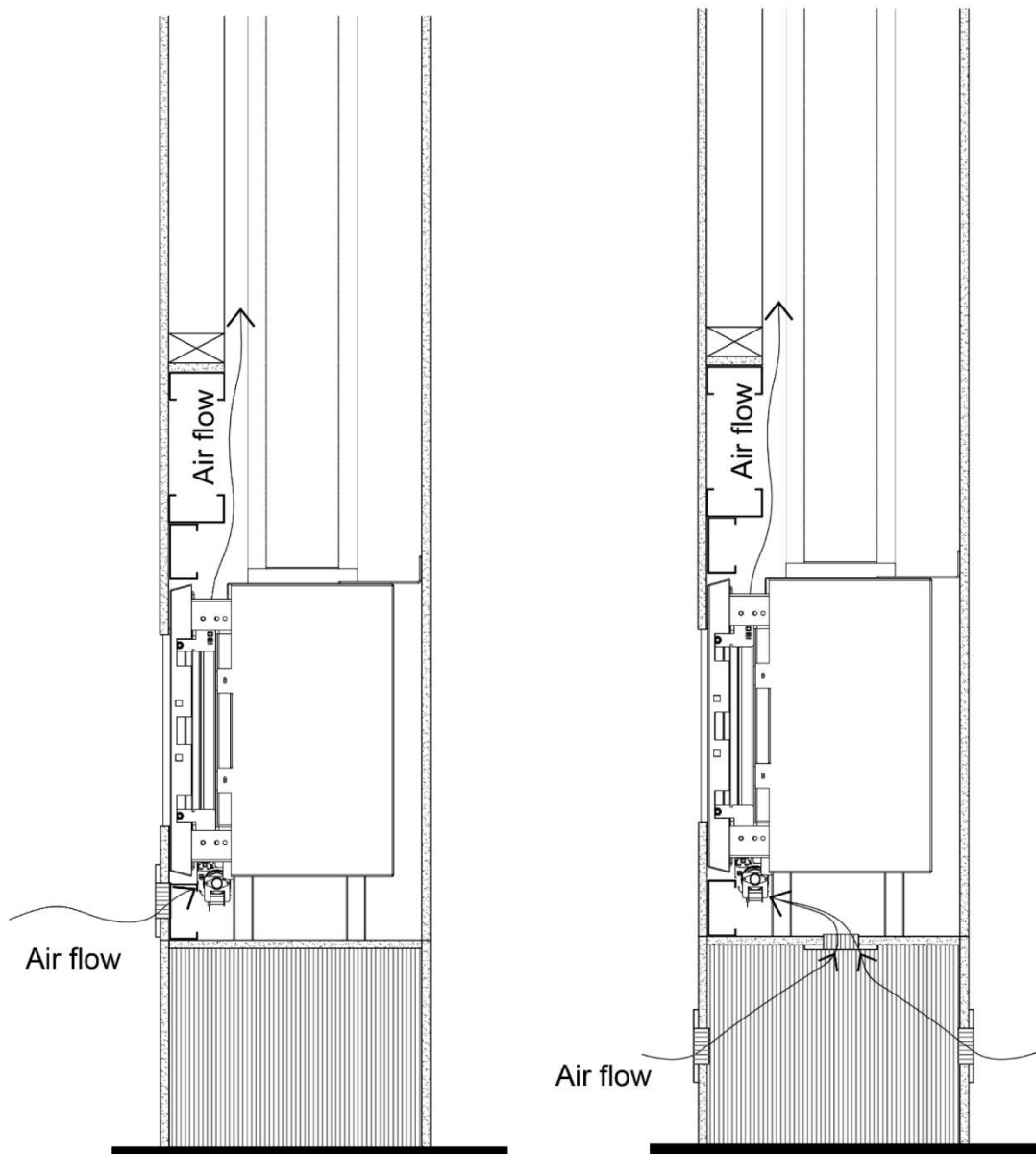

Air Intake as Reveal/Toe-kick

Air Intake for a Platform



LEGEND:

	Non-combustible material such as 5/8" Type X fire rated drywall (or equivalent)		Wood framing
	Combustible material		Metal framing



The air flow area must be free from any obstruction to allow heat from the chase to be released.

Non-combustible material: Material which will not ignite and burn. Such materials are those consisting entirely of steel, iron, brick, tile, concrete, slate, glass or plasters, or any combination thereof. Materials that are reported as passing ASTM E 136, Standard Test Method for Behavior of Materials in a Vertical Tube Furnace at 750 °C shall be considered non-combustible materials. An exception is made only for fire rated 5/8" Type X drywall UL authorized or equivalent. 5/8" Type X drywall may be used as a non-combustible material. For greater heat resistance, fireplace-specific cement boards like those produced by Promafour and Skamol are recommended in place of 5/8" Type X drywall.

Framing Diagrams

The following diagrams show framing dimensions in a flush application as an example. A flush application is not the only possible application for ORTAL fireplaces. Please visit our website for more information.

The leg height used for calculating the framing dimensions in the following diagrams is the double glass leg height 9-13/16", which will be standard leg height for both double glass and screen units starting March 2018 with serial #15275 (see page 13 for details on leg height). For framing diagrams for screen units with a leg height of 8-1/4" manufactured prior to March 2018, please visit our website.

The framing shown in the following diagrams show how to meet the requirements for framing with wood studs. To frame with all metal studs, only one layer of 5/8" type X drywall is required and is on the exterior of the framing, and you don't need any 5/8" type X drywall on the interior. If you plan on putting a TV above the fireplace, you will still need the 2 layers of 5/8" type X drywall, even if you're framing in all metal studs.

Wood Framing Requirements:

- Must have two layers of 5/8" type X drywall – one on the interior and one on the exterior sides of the framing.
- The first 18" above the top of the fireplace glass must be metal framing. This is the minimum and can be made larger.

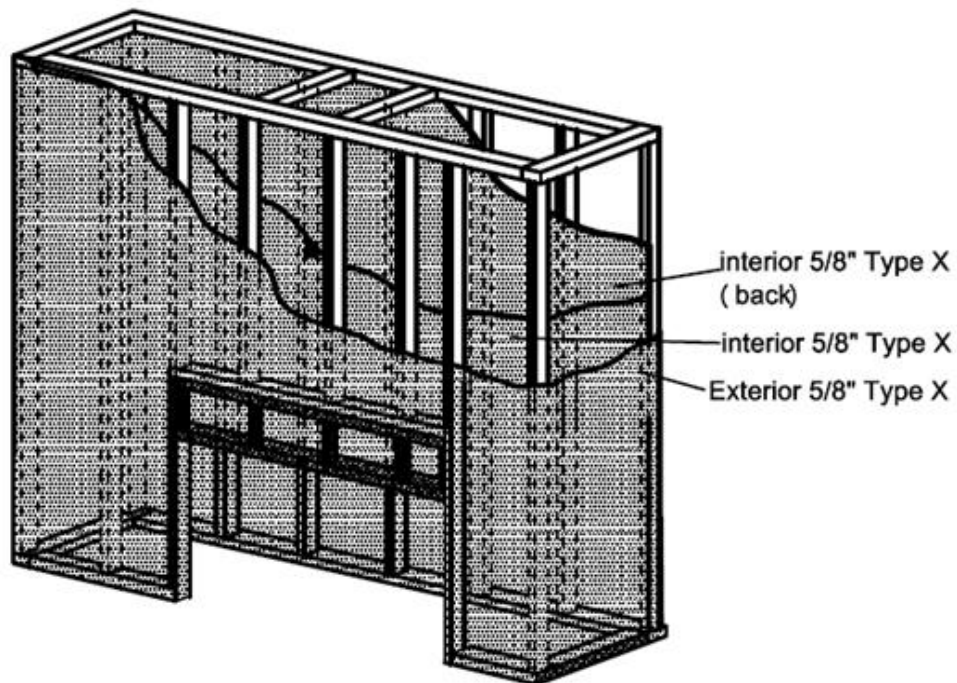

LEGEND

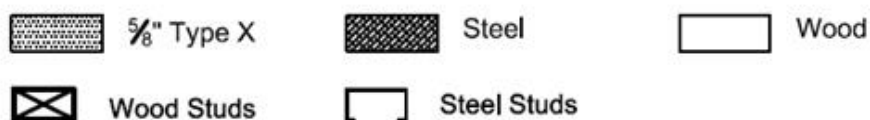

Front (F) & Traditional (TR) Series Framing Diagram

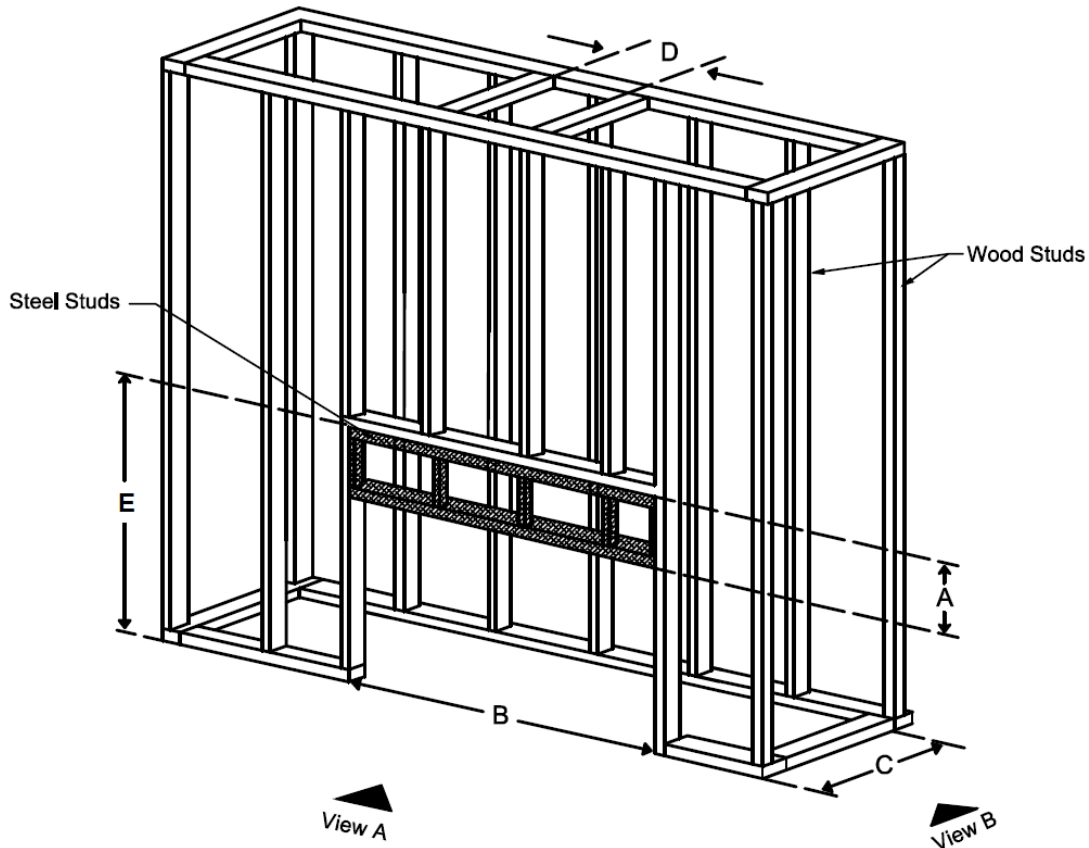

Unit	Dimension A	Dimension B	Dimension C	Dimension D	Dimension E
40H70 F	19-3/4"	25-7/8"	18-3/4"	8-3/4"	61"
60x80 F	18"	30-5/8"	18-11/16"	8-3/4"	61"
75x65 F	22-1/16"	39-9/16"	18-5/8"	8-3/4"	61"
75 F	20-1/16"	38-15/16"	18-5/8"	8/3/4"	50-1/2"
110 F	22-3/8	53-1/8"	18-11/16"	10"	50-1/2"
110H F	19-1/2"	53-13/16"	18-11/16"	10"	55-1/2"
130 F	22-3/8"	59-13/16"	18-11/16"	10"	50-1/2"
130H F	19-1/2"	59-13/16"	18-11/16"	10"	55-1/2"
150 F	22-3/8"	69-11/16"	18-11/16"	10"	50-1/2"
150H F	19-1/2"	69-11/16"	18-11/16"	10"	55-1/2"
170 F	22-3/8"	77-9/16"	18-11/16"	10"	50-1/2"
170H F	19-1/2"	77-9/16"	18-11/16"	10"	55-1/2"
200 F	22-3/8"	87"	18-11/16"	10"	50-1/2"
200H F	19-1/2"	87"	18-11/16"	10"	55-1/2"
250 F	20-7/16"	105-5/8"	18-11/16"	10"	50-1/2"
250H F	19-1/2"	105-5/8"	18-11/16"	10"	55-1/2"
TR 90	20-7/8"	46-1/16"	27-1/8"	10"	67-3/4"
TR 110	18"	53-9/16"	27-1/8"	10"	67-3/4"



NOTE: Dimension A can be as short as 18".

Corner (RS/LS) Series Framing Diagram

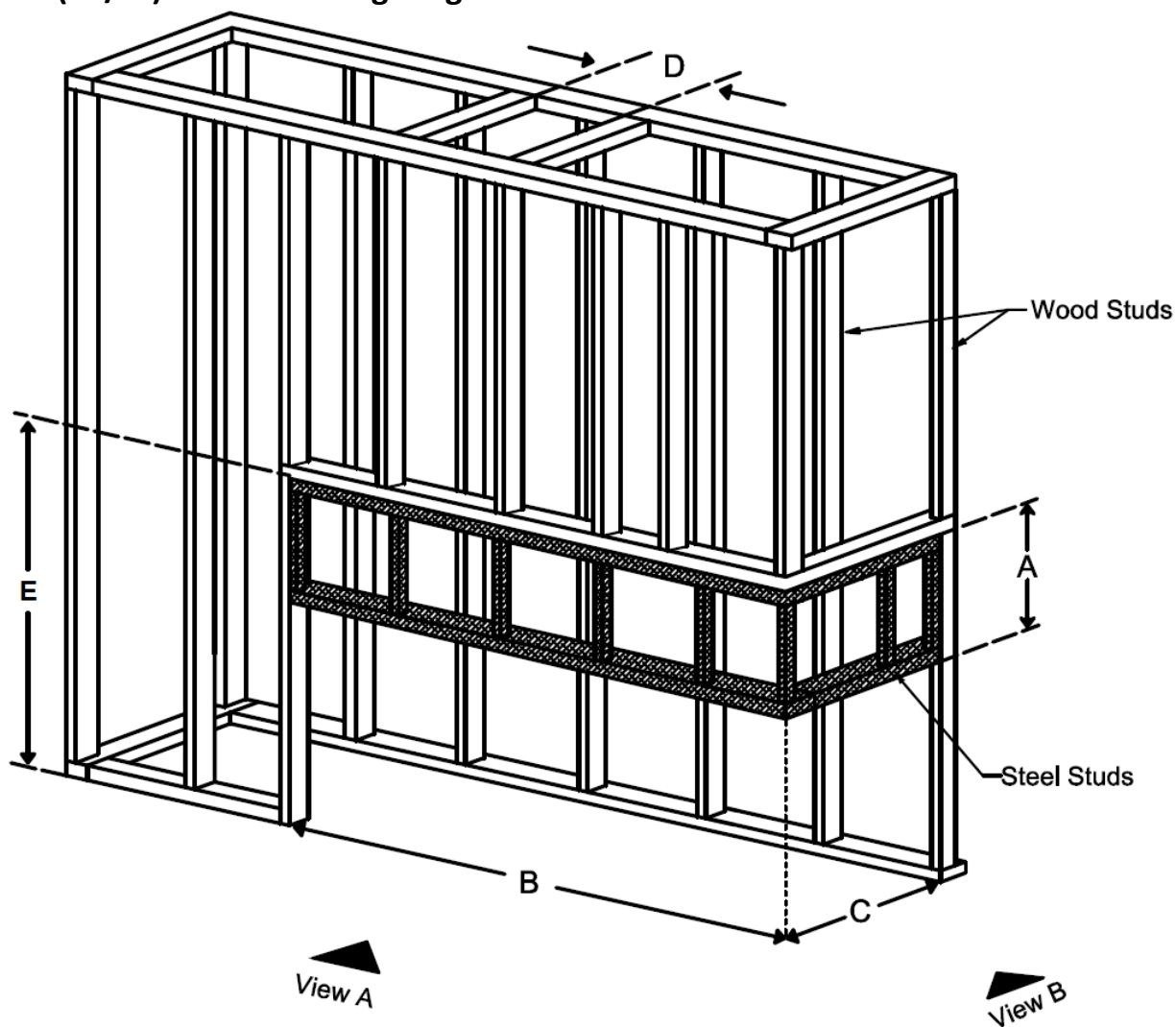

Unit	Dimension A	Dimension B	Dimension C	Dimension D	Dimension E
40H70 RS/LS	19-9/16"	24-3/16"	18-3/4"	8-3/4"	61"
75 RS/LS	18"	35-13/16"	20-3/4"	8-3/4"	50-1/2"
110 RS/LS	20-7/16"	51-3/8"	21-3/16"	10"	50-1/2"
110H RS/LS	18"	51-9/16"	22-7/8"	10"	55-1/2"
130 RS/LS	20-7/16"	58"	21-3/16"	10"	50-1/2"
130H RS/LS	18"	58-1/4"	22-7/8"	10"	55-1/2"
150 RS/LS	20-7/16"	67-7/8"	21-3/16"	10"	50-1/2"
150H RS/LS	18"	68-1/16"	22-7/8"	10"	55-1/2"
170 RS/LS	20-7/16"	75-3/4"	21-3/16"	10"	50-1/2"
170H RS/LS	18"	75-15/16"	22-7/8"	10"	55-1/2"
200 RS/LS	20-7/16"	85-3/16"	21-3/16"	10"	50-1/2"
200H RS/LS	18"	85-7/16"	22-7/8"	10"	55-1/2"
250 RS/LS	20-7/16"	104-7/8"	21-3/16"	10"	50-1/2"
250H RS/LS	18"	105-1/8"	22-7/8"	10"	55-1/2"



NOTE: Dimension A can be as short as 18".

Tunnel (TN) Framing Diagram

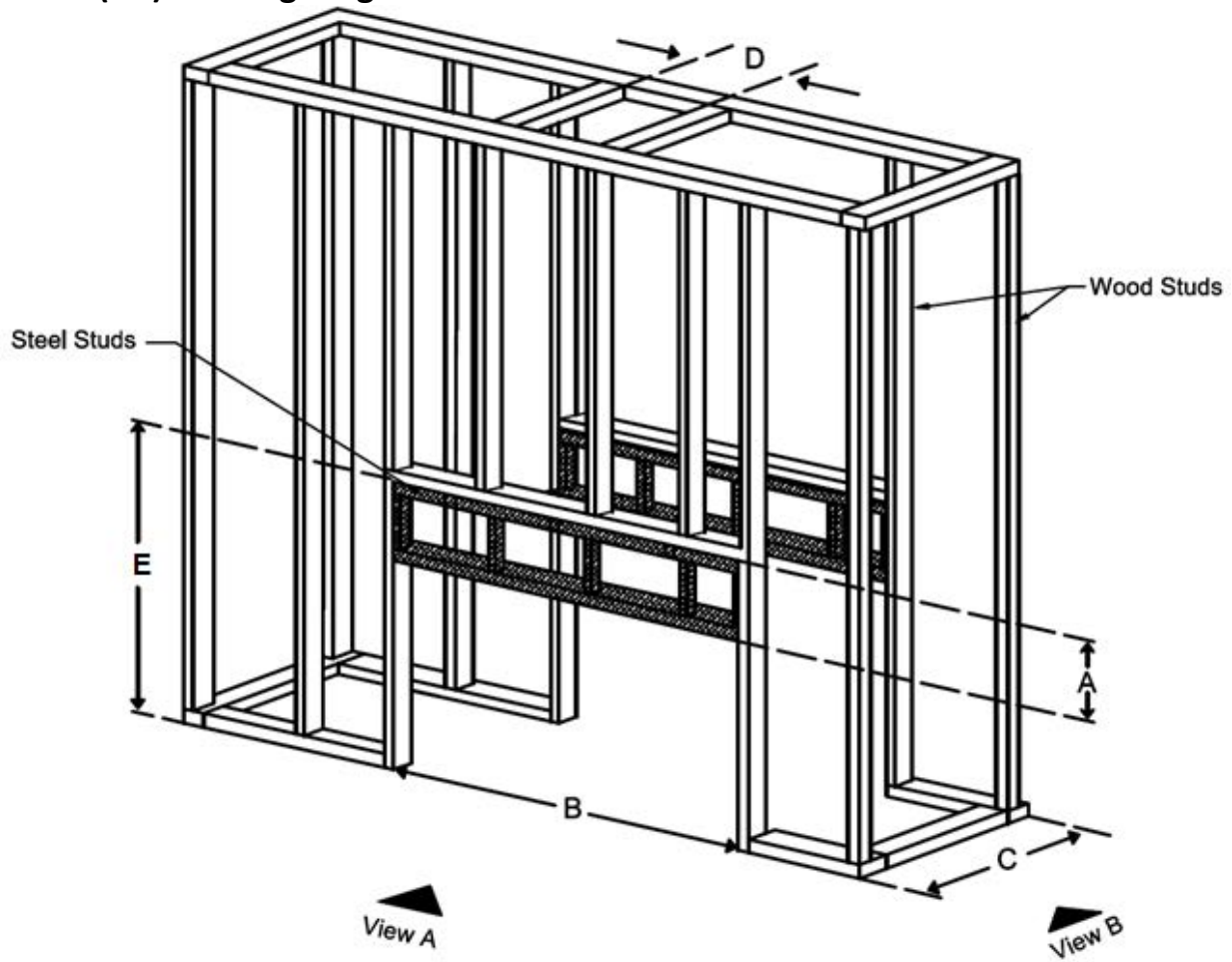

Unit	Dimension A	Dimension B	Dimension C	Dimension D	Dimension E
40H70 TN	19-7/8"	25-7/8"	19-1/16"	8-3/4"	61"
60x80 TN	18"	30-5/8"	19-1/16"	8-3/4"	8-3/4"
75x65 TN	22-1/16"	39-9/16"	19-1/16"	8-3/4"	61"
110 TN	22-7/16"	53-1/8"	19-3/16"	10"	50-1/2"
110H TN	19-9/16"	53-13/16"	19-3/16"	10"	55-1/2"
130 TN	22-7/16"	59-13/16"	19-3/16"	10"	50-1/2"
130H TN	19-9/16"	59-13/16"	19-3/16"	10"	55-1/2"
150 TN	22-7/16"	69-11/16"	19-3/16"	10"	50-1/2"
150H TN	19-9/16"	69-11/16"	19-3/16"	10"	55-1/2"
170 TN	22-7/16"	77-9/16"	19-3/16"	10"	50-1/2"
170H TN	19-9/16"	77-9/16"	19-3/16"	10"	55-1/2"
200 TN	22-7/16"	87"	19-3/16"	10"	50-1/2"
200H TN	19-9/16"	87"	19-3/16"	10"	55-1/2"
250 TN	20-5/16"	105-1/2"	19-3/16"	10"	50-1/2"
250H TN	19-7/16"	105-1/2"	19-3/16"	10"	55-1/2"



NOTE: Dimension A can be as short as 18".

Three Side (TS) Framing Diagram

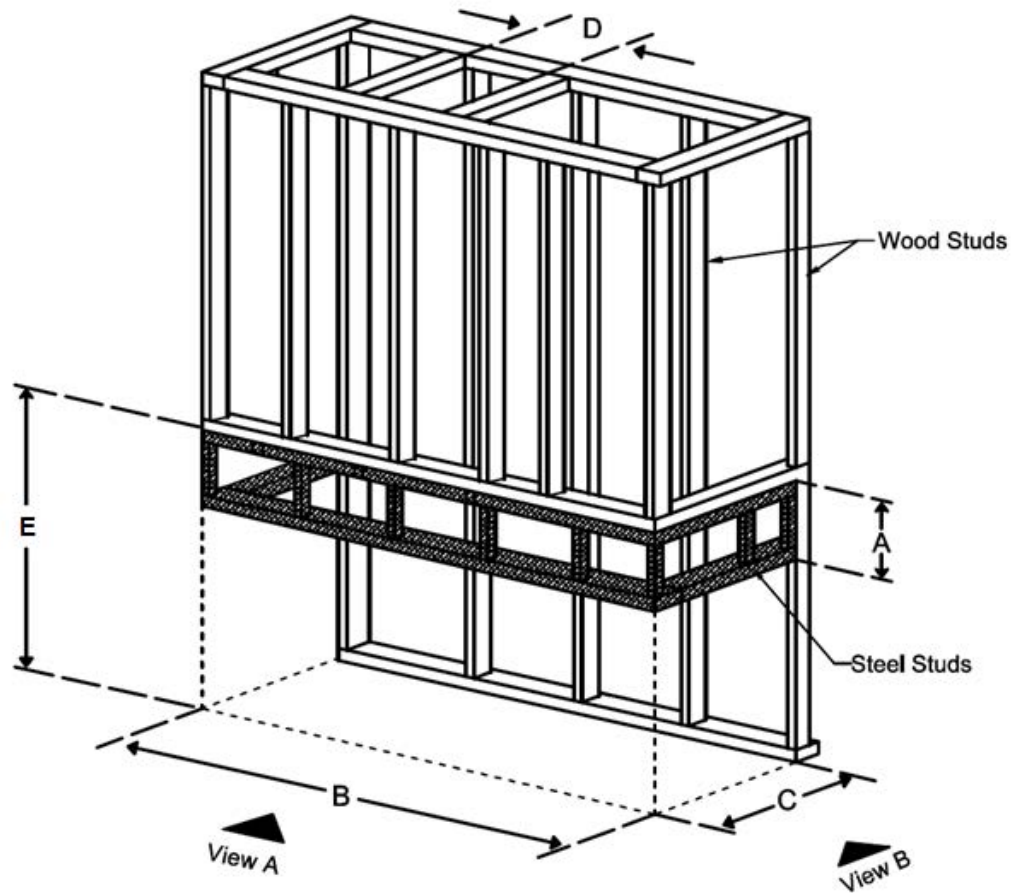

Unit	Dimension A	Dimension B	Dimension C	Dimension D	Dimension E
40H70 TS	19-9/16"	22-5/16"	18-7/8"	8-3/4"	61"
75 TS	18"	33-9/16"	20-11/16"	8-3/4"	50-1/2"
110 TS	20-7/16"	48-15/16"	21-3/16"	10"	50-1/2"
110H TS	18-1/16"	48-15/16"	22-7/8"	10"	55-1/2"
130 TS	20-7/16"	55-5/8"	21-3/16"	10"	50-1/2"
130H TS	18-1/16"	55-5/8"	22-7/8"	10"	55-1/2"
150 TS	20-7/16"	65-7/16"	21-3/16"	10"	50-1/2"
150H TS	18-1/16"	65-7/16"	22-7/8"	10"	55-1/2"
170 TS	20-7/16"	73-5/16"	21-3/16"	10"	50-1/2"
170H TS	18-1/16"	73-5/16"	22-7/8"	10"	55-1/2"
200 TS	20-7/16"	82-3/4"	21-3/16"	10"	50-1/2"
200H TS	18-1/16"	82-3/4"	22-7/8"	10"	55-1/2"
250 TS	20-7/16"	102-7/16"	21-3/16"	10"	50-1/2"
250H TS	18-1/16"	102-7/16"	22-7/8"	10"	55-1/2"



NOTE: Dimension A can be as short as 18".

Space Creator (SC) Framing Diagram

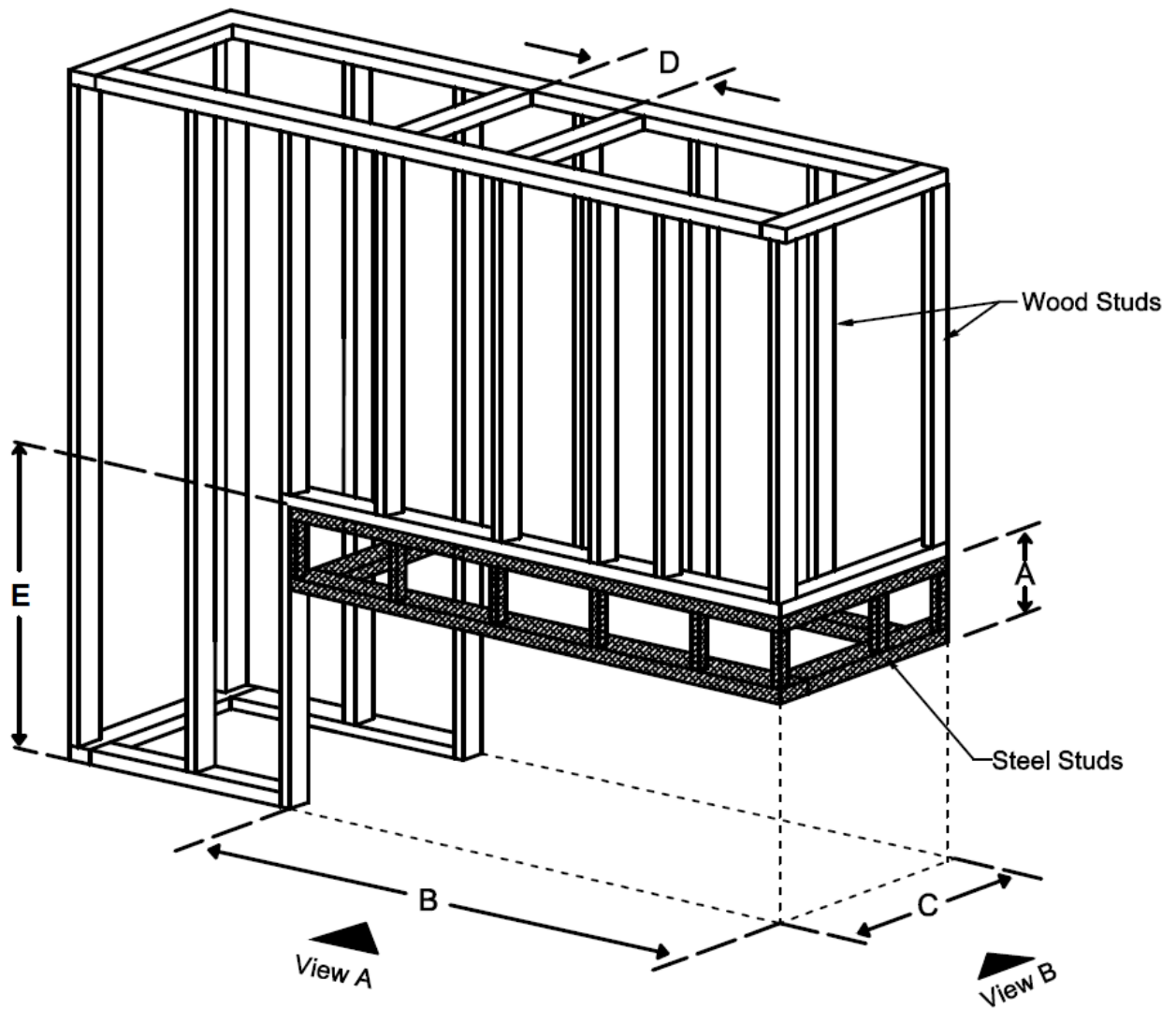

Unit	Dimension A	Dimension B	Dimension C	Dimension D	Dimension E
SC 75	19"	37-15/16"	19-3/8"	8-3/4"	50-1/2"
SC 120	18-1/4"	57-5/16"	19-3/8"	10"	50-1/2"
SC 150	18-1/4"	69-3/16"	19-3/8"	10"	50-1/2"
SC 200	18-1/4"	89-1/4"	19-3/8"	10"	50-1/2"



NOTE: Dimension A can be as short as 18".

Clearance & Finish Diagrams

General Clearance Requirements

Maintain clearances as shown in the figures below. Clearances are to non-combustible materials, or 5/8" Type X drywall or its equivalent.

FRONT (F) & TRADITIONAL (TR)

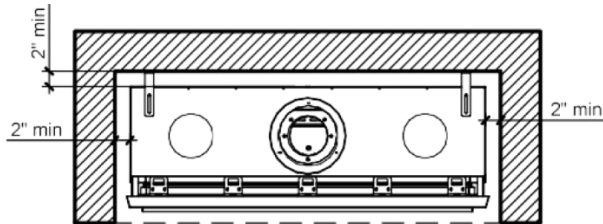

TUNNEL (TN)

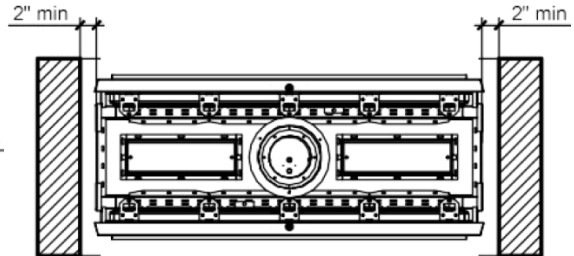

LEFT SIDE (LS)

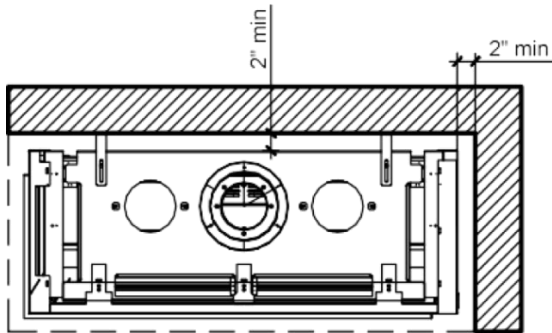

RIGHT SIDE (RS)

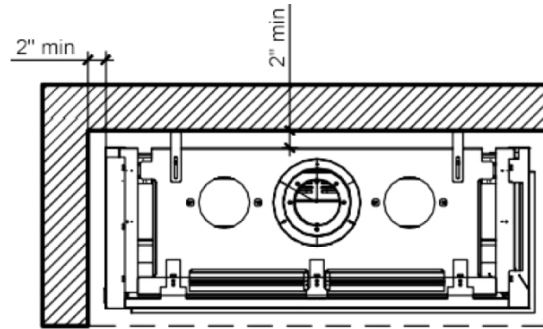

SPACE CREATOR (SC)

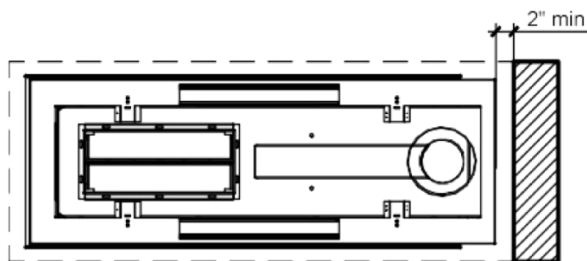

THREE SIDES (TS)

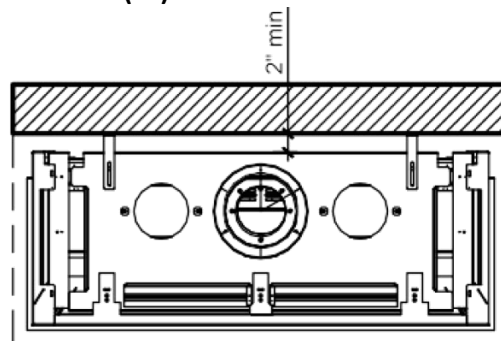

Fireplace Recess/Overhang: A recessed fireplace cannot have a top overhang deeper than 4-1/2" (including finish materials). This restriction applies to all glass sides in multisided units as well.

Framing Clearance: Maintain 1/4" of space between your framing and the firebox.

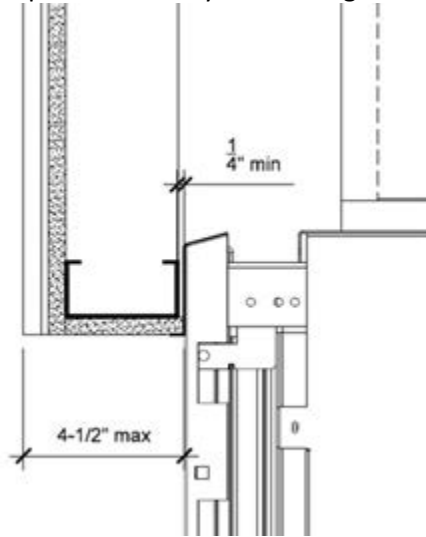

Air Flow Clearance: Maintain a minimum of 4" clearance above the top firebox vents to allow air to flow through the screen or double glass into the fireplace chase.

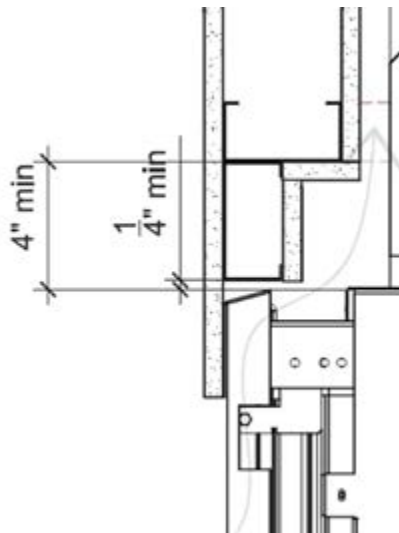

NOTE: Current framing drawings and dimensions for each model can also be found on our website.

Minimum Firebox Clearances Diagram

The following diagram shows the minimum clearances to the sides and back of any built-in ORTAL fireplace.

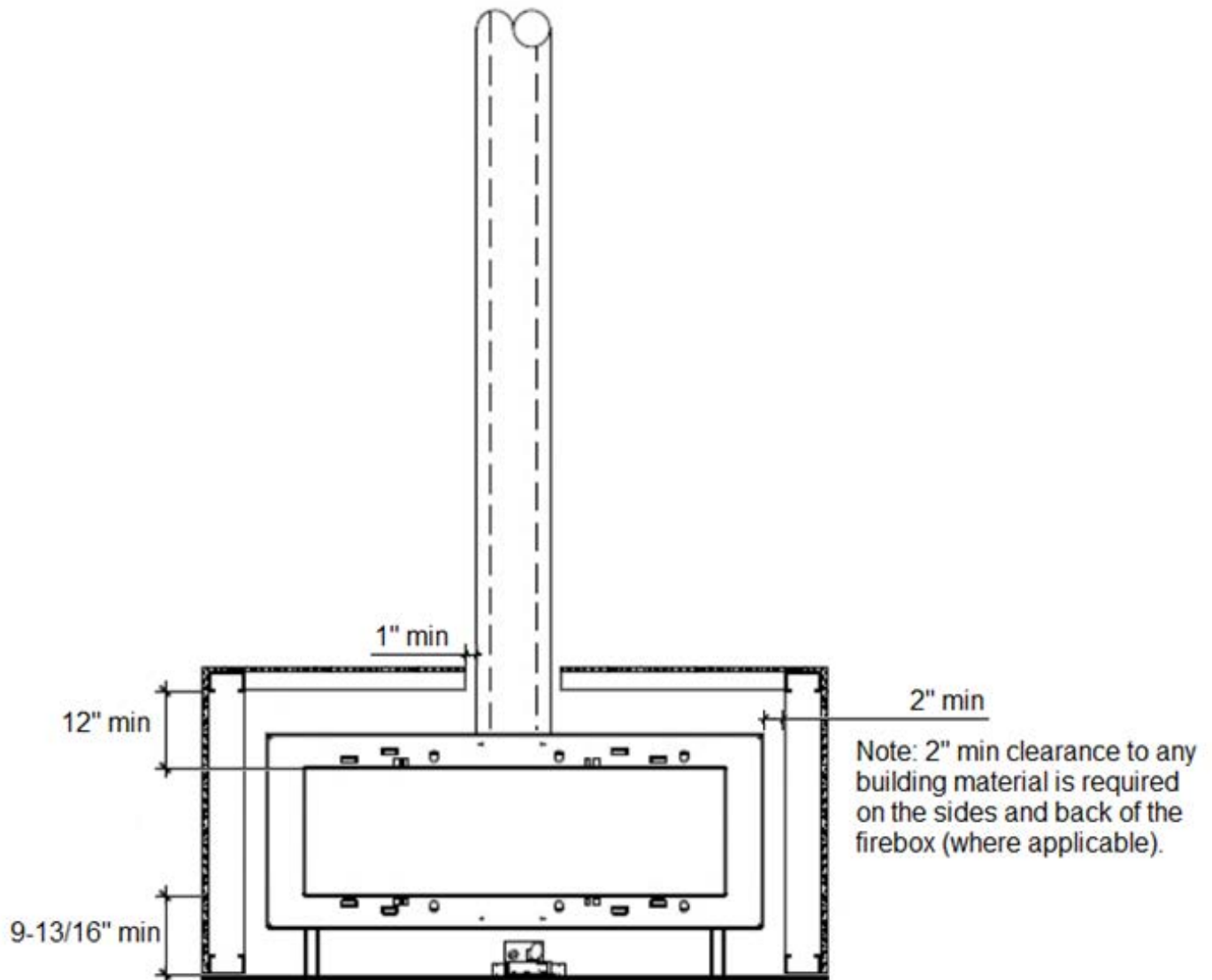

NOTES:

- The clearances mentioned in the diagrams on the immediately previous page apply to the front of the firebox.
- The 12" clearance spans from the top of the fireplace viewing area to the bottom of the framing.
- The 9-13/16" clearance spans from the bottom of the legs to the bottom of the fireplace viewing area. Legs are not removable or adjustable.
- While not shown in this diagram, a heat release is required for all built-in ORTAL appliances (see section labeled "Heat Release" details). An air intake is also required for all built-in ORTAL fireplaces with the double glass heat barrier (see section labeled "Air Intake" details).

Clearance to Furniture & Other Combustibles

Furniture and other combustibles are not permitted within 36" of the fireplace glass. The diagram below shows a Three Side model as an example.

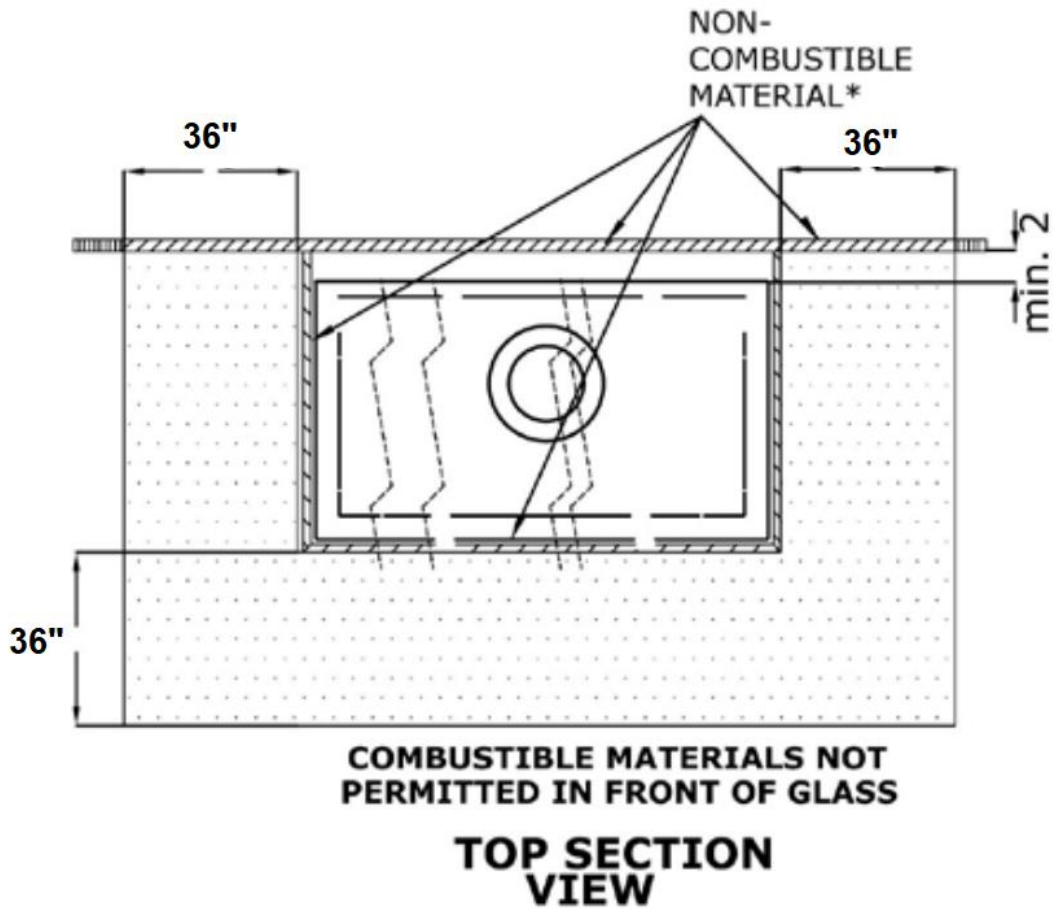

Inside Corner Clearances

The diagram below shows inside corner options. No combustible material should be placed within the dimensions shown. This diagram only applies if there is a wall on one or both sides of the fireplace.

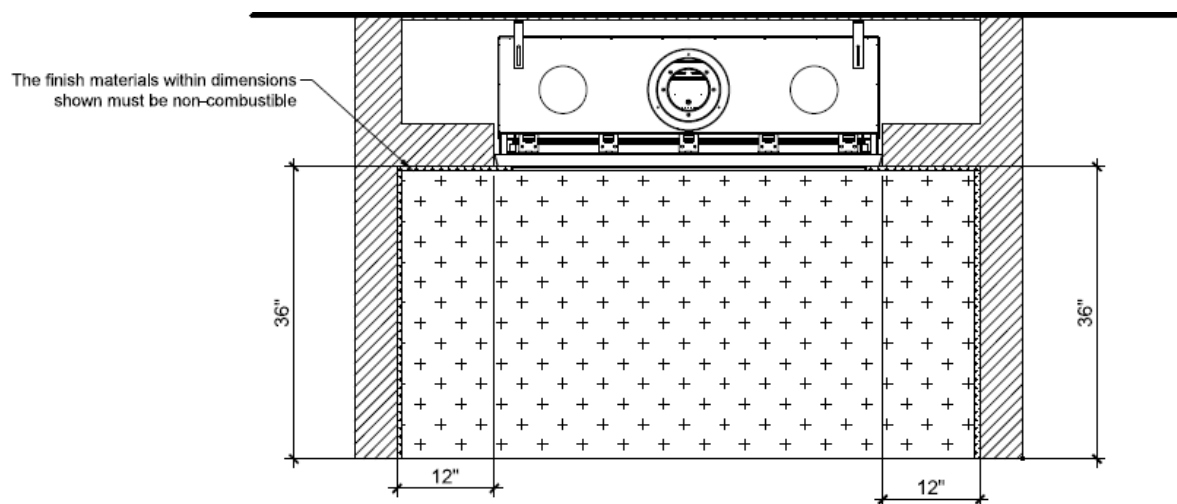

Television/Art Installation Information & Diagrams

ORTAL's Cool Wall Technology is a technique that reduces the heat from the glass and the firebox and prevents heat buildup, mitigating any damage that may result from high heat temperatures. ORTAL's Cool Wall system enables the option of installing artwork, a TV, or other similar electronic components above the fireplace:

Location	Wall Temperature
0-6" above ORTAL firebox	100°F - 120°F
6-12" above ORTAL firebox	90°F - 100°F
Recommended minimum clearance between bottom edge of TV or other similar device or artwork and top of firebox opening is 12".	
12" above ORTAL firebox	80°F - 90°F

TV and Art Mounting Requirements

ORTAL requires the following general guidelines to mount a TV or artwork above the fireplace and prevent heat damage:

- Mount the TV or artwork a minimum of 12 inches above the top opening of the firebox.
- Line the interior and exterior of your framing with fire rated 5/8 Type X drywall (or equivalent), regardless of your framing material (wood studs vs. metal studs).
- Make sure the TV or artwork is never flush with the wall above the fireplace.

The following recommendation will further mitigate heat impact to electronics and art work, but is not a requirement:

- Use mineral wool insulation in the air space between Type X drywall layers.



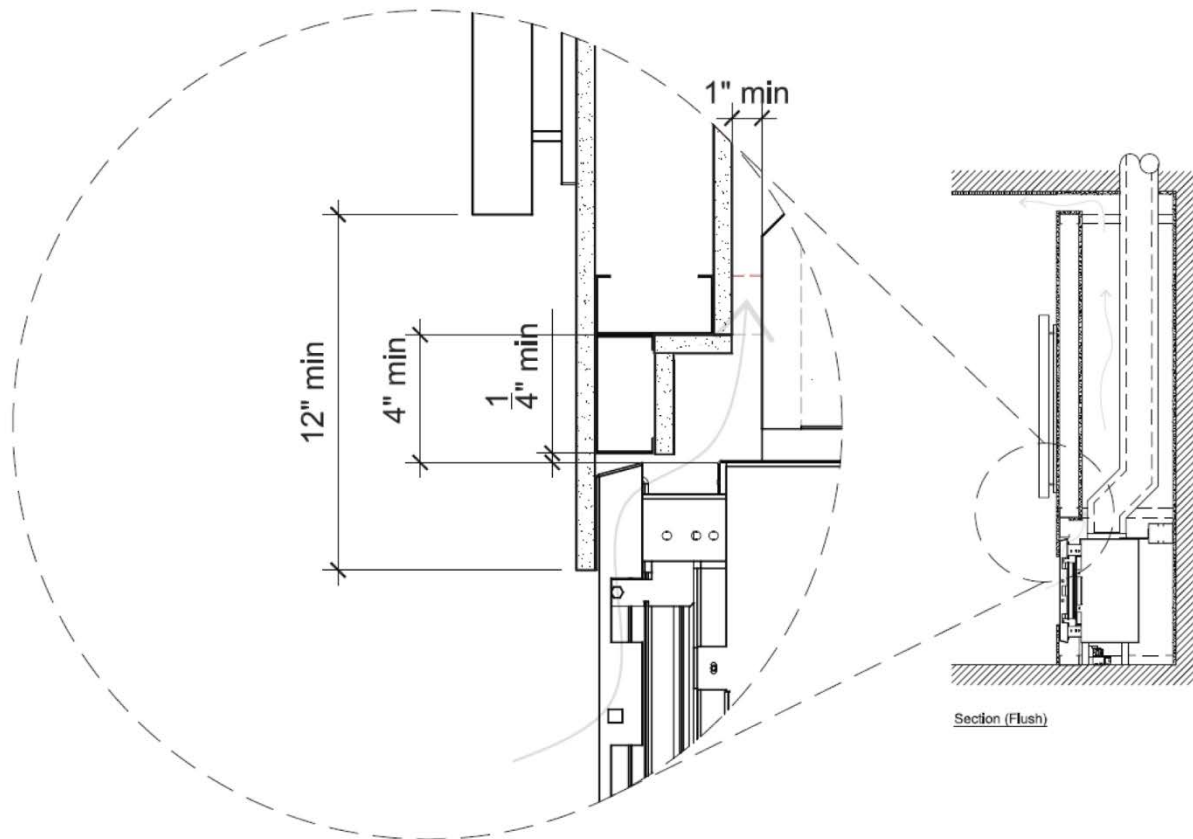

The decision to install a television above an ORTAL fireplace is up to the discretion of the consumer. TV and art manufacturers may specify in their instructions that the product should not be installed on, near or above a heat source. ORTAL will not be held liable for any adverse effects on a TV, artwork or other equipment located near the ORTAL appliance. It is the customer's responsibility to verify that their TV or artwork can withstand the wall temperatures as outlined in the previous wall temperature chart.

The drawings in the following sections can be used as a guide for customers who do decide to locate their TV and artwork above their ORTAL appliance. These drawings illustrate ways of reducing the amount of heat impact to the area surrounding the fireplace.

TV Detail for a Flush Fireplace and Mounted TV



LEGEND:

	Non-combustible material such as 5/8" Type X fire rated drywall (or equivalent)		Wood framing
	Combustible material		Metal framing

 The air flow area must be free from any obstruction to allow heat from the chase to be released.

Non-combustible material: Material which will not ignite and burn. Such materials are those consisting entirely of steel, iron, brick, tile, concrete, slate, glass or plasters, or any combination thereof. Materials that are reported as passing ASTM E 136, Standard Test Method for Behavior of Materials in a Vertical Tube Furnace at 750 °C shall be considered non-combustible materials. An exception is made only for fire rated 5/8" Type X drywall UL authorized or equivalent. 5/8" Type X drywall may be used as a non-combustible material. For greater heat resistance, fireplace-specific cement boards like those produced by Promafour and Skamol are recommended in place of 5/8" Type X drywall.

TV Detail for a Recessed Fireplace and Recessed TV

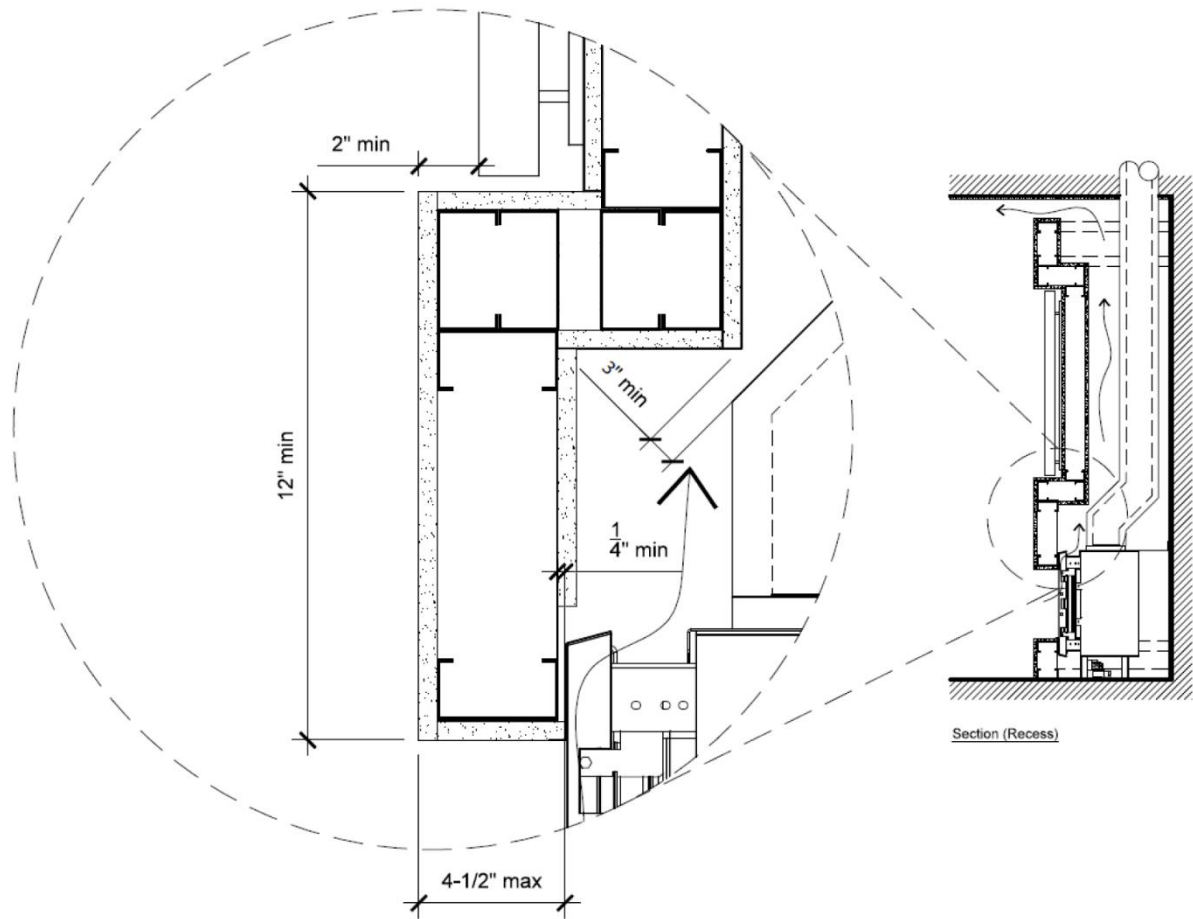

LEGEND:

	Non-combustible material such as 5/8" Type X fire rated drywall (or equivalent)		Wood framing
	Combustible material		Metal framing

The air flow area must be free from any obstruction to allow heat from the chase to be released.

Non-combustible material: Material which will not ignite and burn. Such materials are those consisting entirely of steel, iron, brick, tile, concrete, slate, glass or plasters, or any combination thereof. Materials that are reported as passing ASTM E 136, Standard Test Method for Behavior of Materials in a Vertical Tube Furnace at 750 °C shall be considered non-combustible materials. An exception is made only for fire rated 5/8" Type X drywall UL authorized or equivalent. 5/8" Type X drywall may be used as a non-combustible material. For greater heat resistance, fireplace-specific cement boards like those produced by Promafour and Skamol are recommended in place of 5/8" Type X drywall.

Finish Diagrams

The following diagrams show various finish applications.

Non-Combustible (Stone) Finish

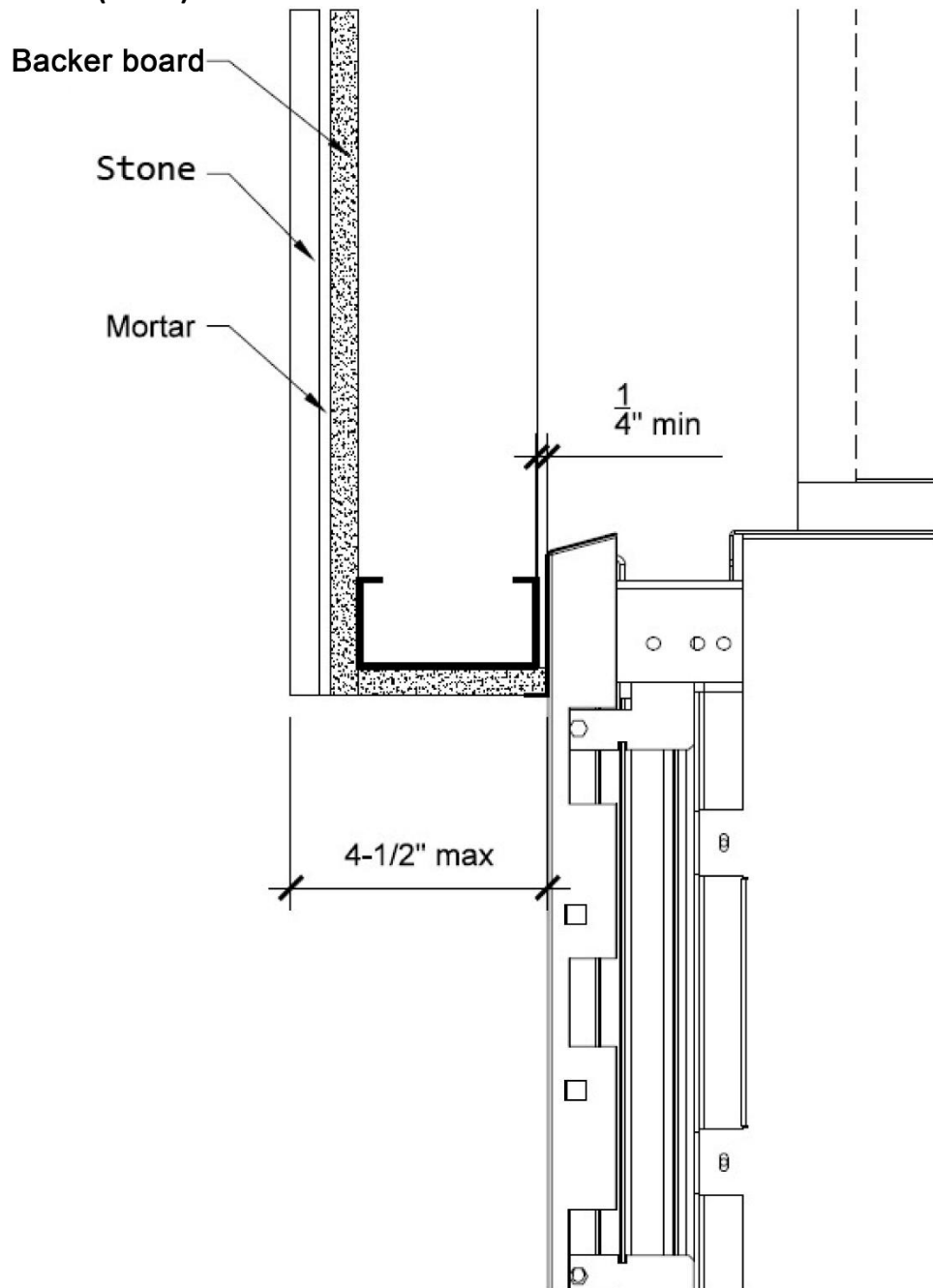

NOTES:

- For manufactured stone products, a minimum 2" recess is recommended. The clearance requirements will be determined by the stone manufacturer. Natural stone finishes do not require a recessed application and may be flush with the appliance.
- Only your Type X or equivalent material (like backer board) is permitted to touch the unit.

Non-Combustible (Stone) Finish with Non-combustible Hearth Extension

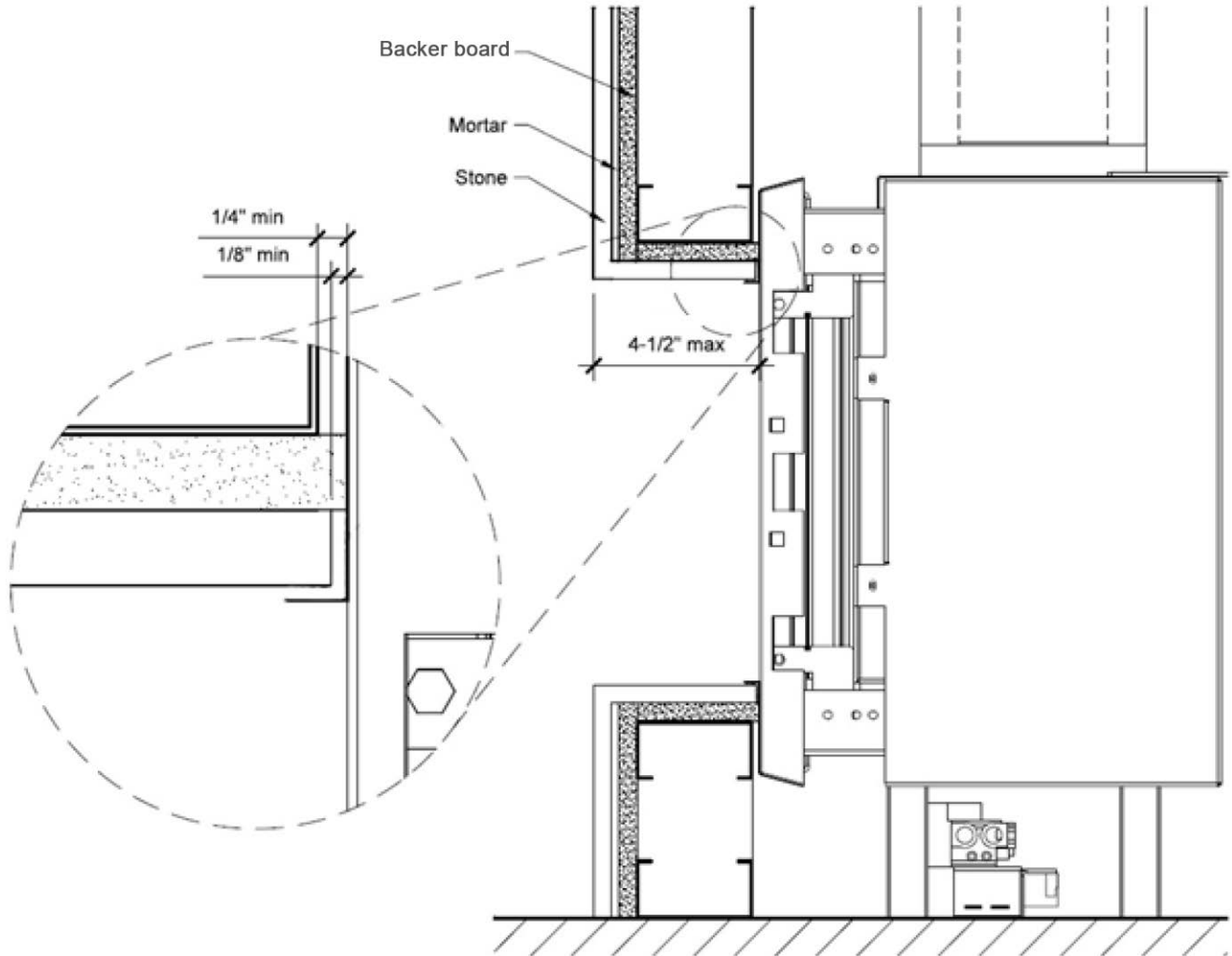

NOTES:

- For manufactured stone products, a minimum 2" recess is recommended. The clearance requirements will be determined by the stone manufacturer. Natural stone finishes do not require a recessed application and may be flush with the appliance.
- Only your Type X or equivalent material (like backer board) is permitted to touch the unit.



HEARTH EXTENSION NOTES:

- The framing must maintain a 1/4" clearance to the firebox
- The finish must maintain at least a 1/8" clearance to the firebox.
- Don't frame or finish above the bottom lip of the firebox (otherwise the fireplace glass cannot be removed).

Brick Veneer Finish

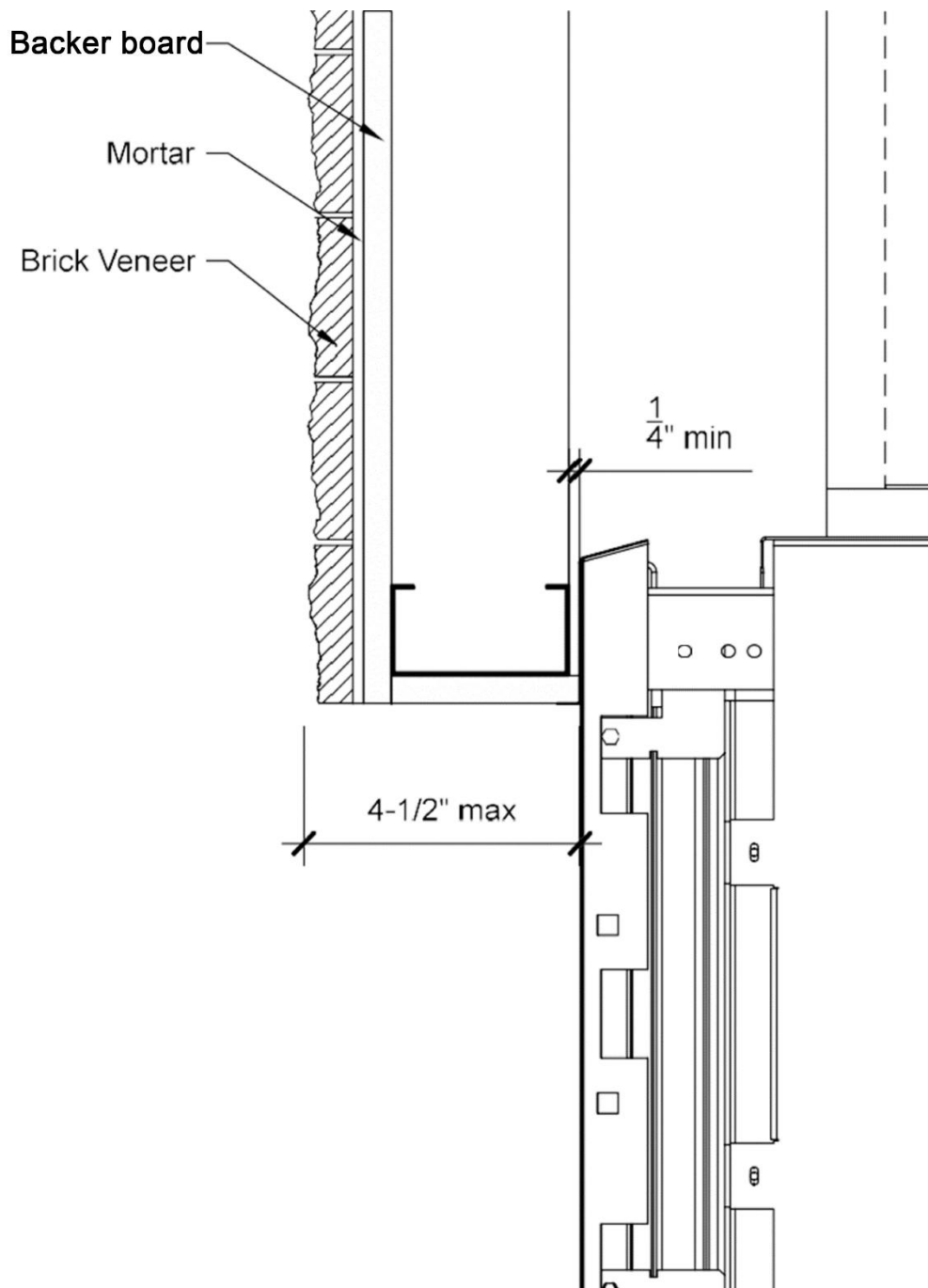

NOTES:

- A recessed application is not required. Brick Veneer may be installed flush to the appliance.
- Only your Type X or equivalent material (like backer board) is permitted to touch the unit.

Recessed Combustible (Wood) Finish

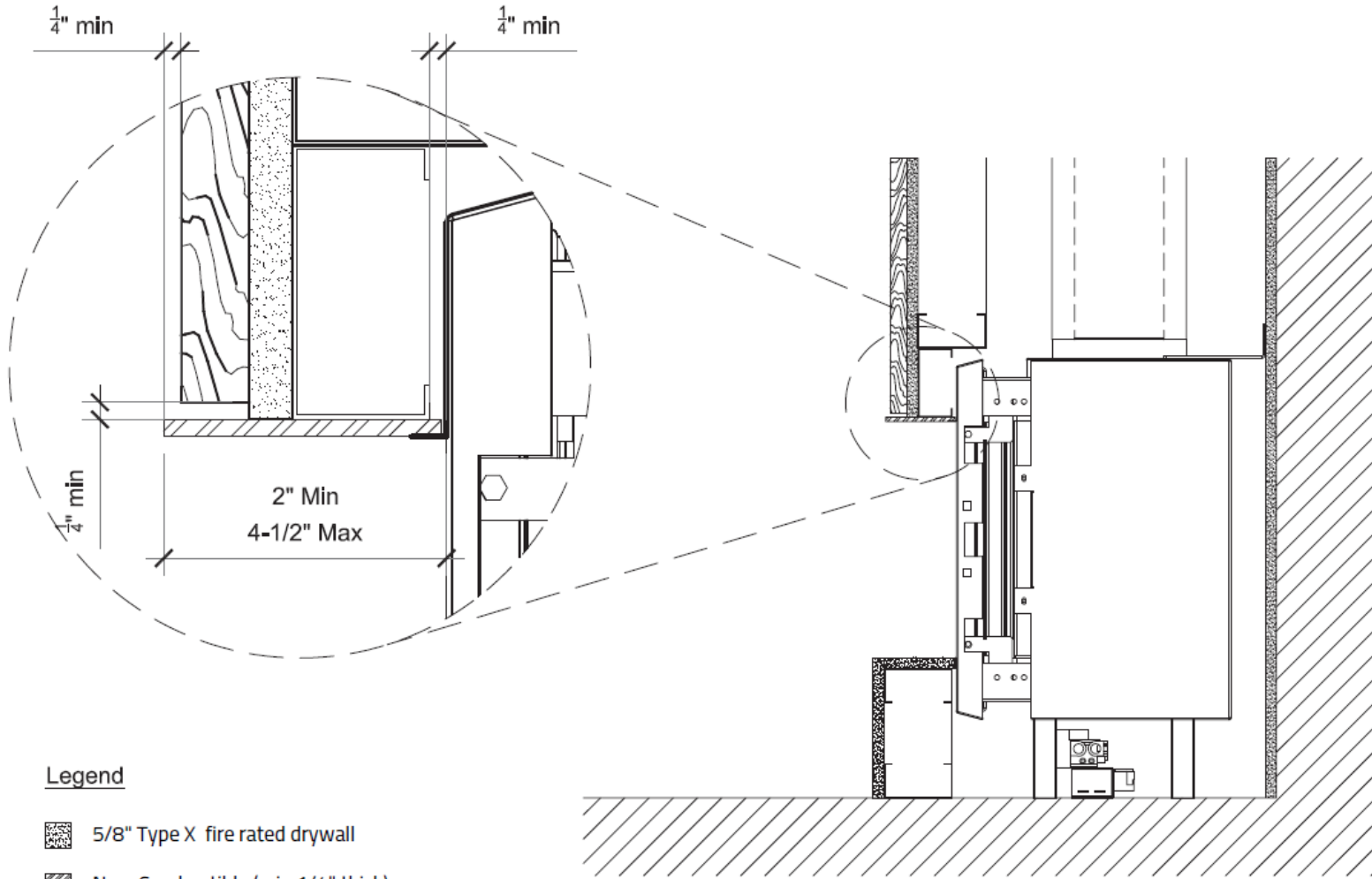

Flush Combustible (Wood) Finish

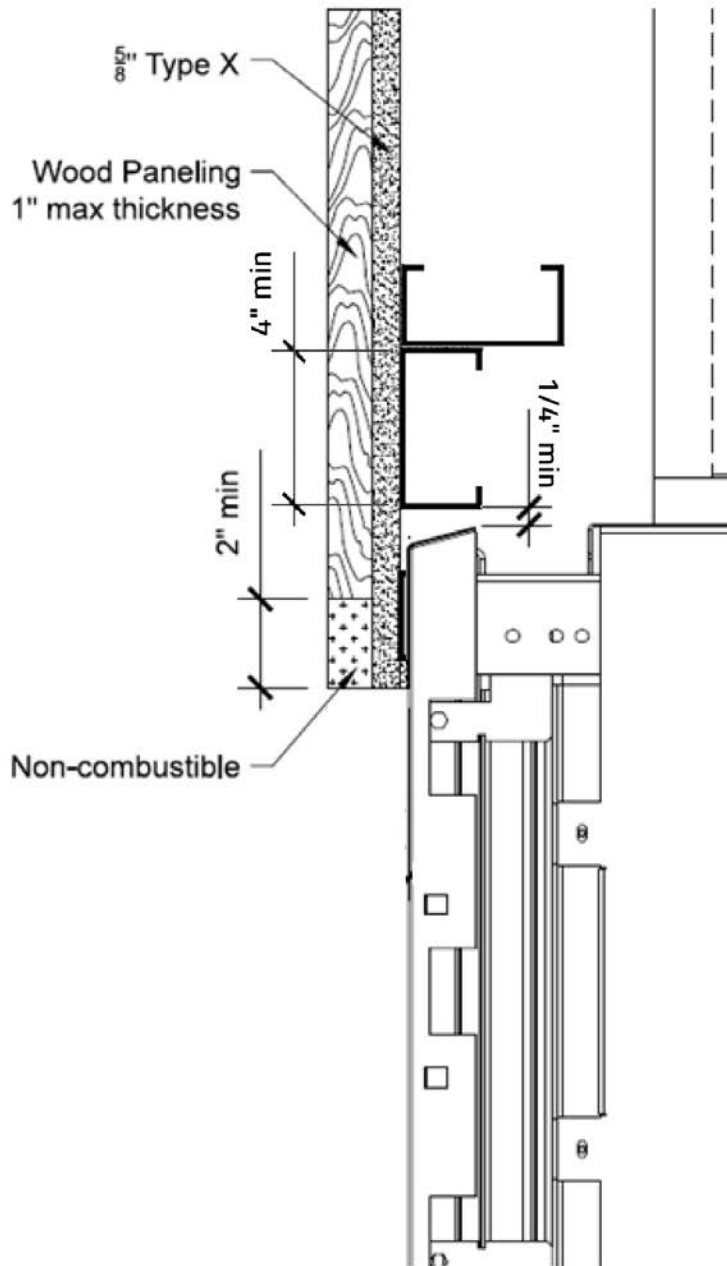



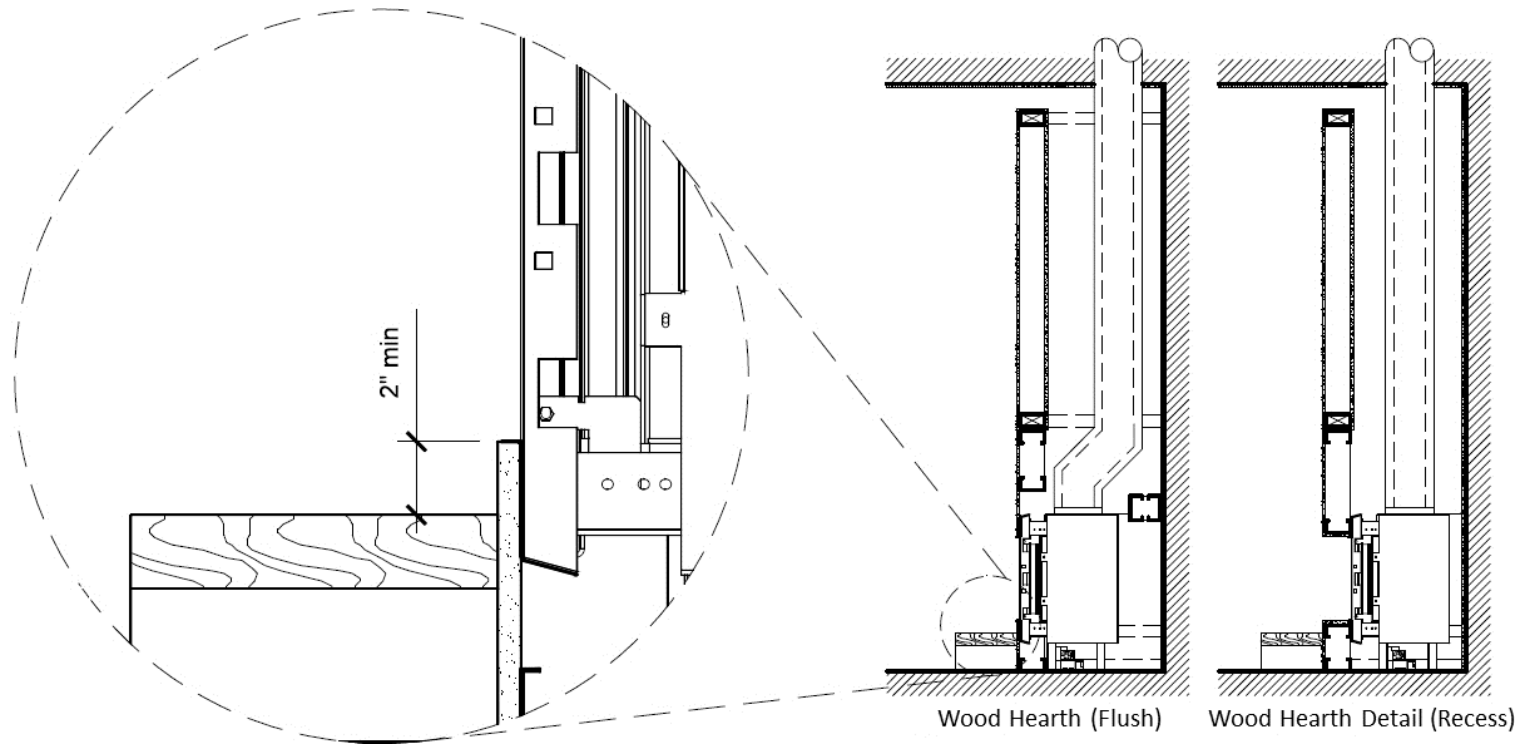

NOTE: Non-combustible trim goes around the entire fireplace opening as a border.

Wood Hearth Extension



⚠ WARNING – Wood hearth extensions may dry out, crack, warp or become discolored.

LEGEND:

	Non-combustible material such as 5/8" Type X fire rated drywall (or equivalent)		Wood framing
	Combustible material		Metal framing

⚠ The air flow area must be free from any obstruction to allow heat from the chase to be released.

Non-combustible material: Material which will not ignite and burn. Such materials are those consisting entirely of steel, iron, brick, tile, concrete, slate, glass or plasters, or any combination thereof. Materials that are reported as passing ASTM E 136, Standard Test Method for Behavior of Materials in a Vertical Tube Furnace at 750 °C shall be considered non-combustible materials. An exception is made only for fire rated 5/8" Type X drywall UL authorized or equivalent. 5/8" Type X drywall may be used as a non-combustible material. For greater heat resistance, fireplace-specific cement boards like those produced by Promafour and Skamol are recommended in place of 5/8" Type X drywall.



NOTES:

- A hearth extension is not required for any ORTAL fireplaces, but it can be used as a design feature.
- A hearth extension and/or non-combustible hearth zone is not required for the Ortal Traditional series. The Traditional series may sit flush to any surface other than carpet without a non-combustible hearth zone.



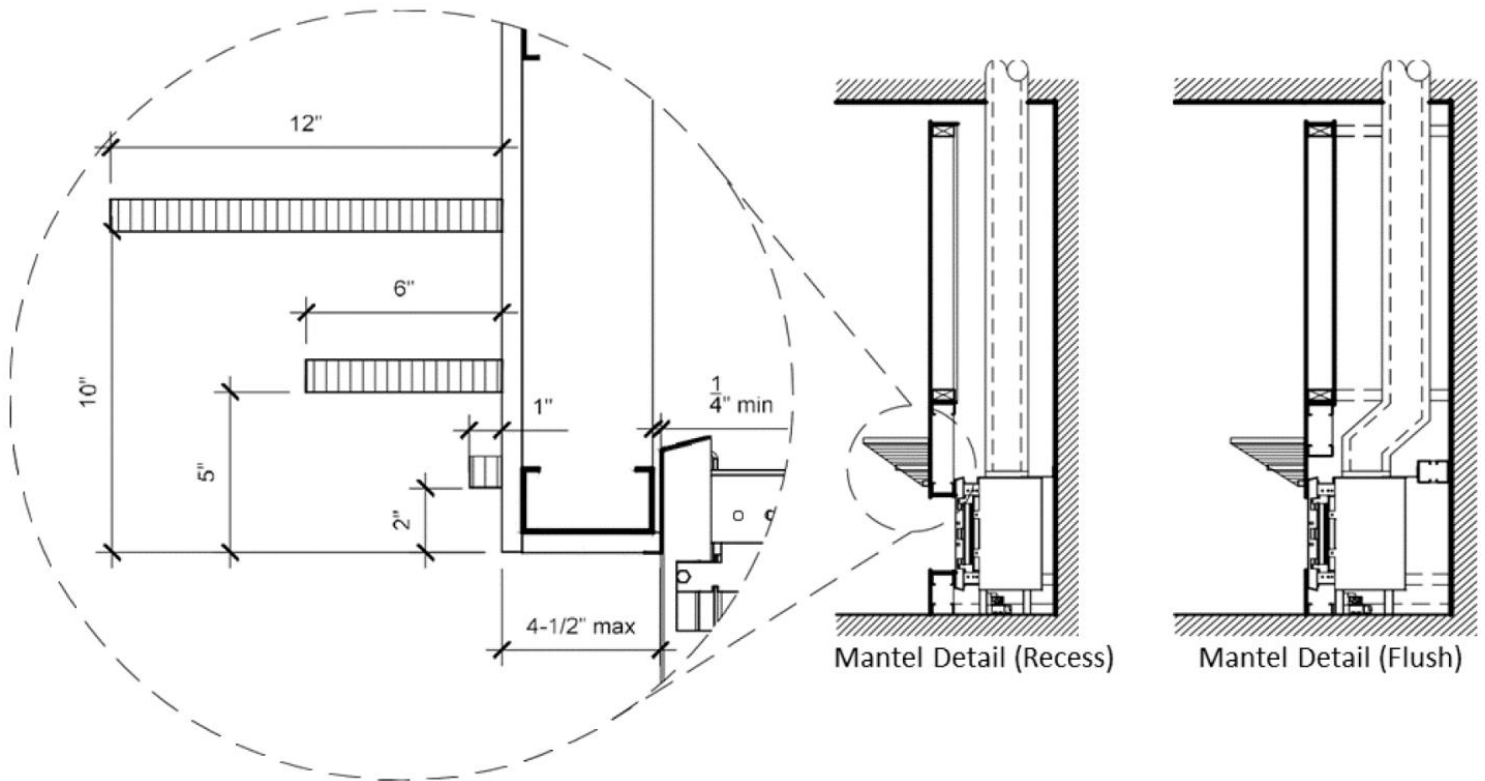

Mantel Diagrams

A mantel is not required for any ORTAL fireplaces but may be incorporated as a design feature. The following diagrams show how to safely design a mantel above your ORTAL fireplace.

Mantel Detail for a Recess and Flush Application



LEGEND:

	Non-combustible material such as 5/8" Type X fire rated drywall (or equivalent)		Wood framing
	Combustible material		Metal framing



The air flow area must be free from any obstruction to allow heat from the chase to be released.



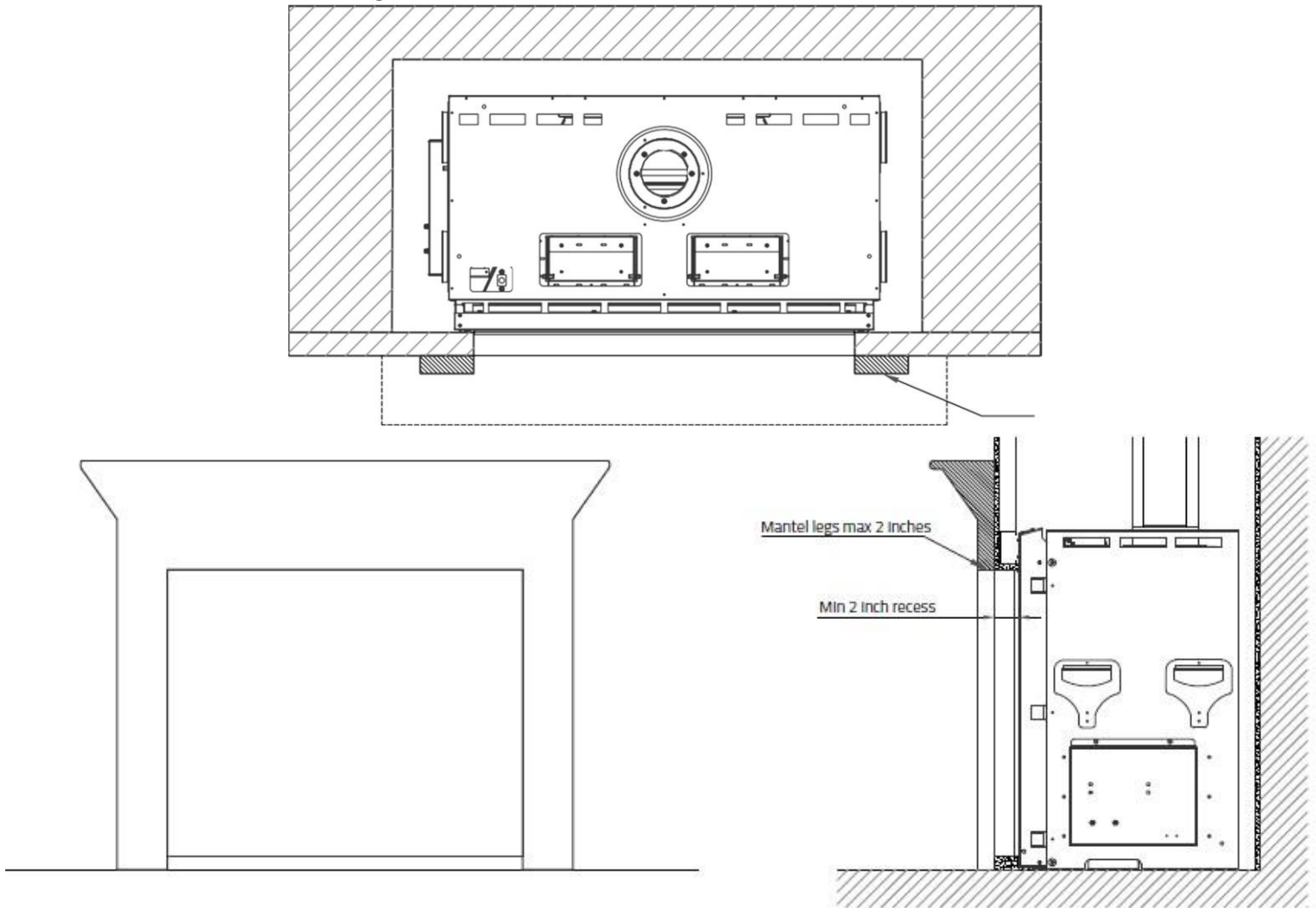

Non-combustible material: Material which will not ignite and burn. Such materials are those consisting entirely of steel, iron, brick, tile, concrete, slate, glass or plasters, or any combination thereof. Materials that are reported as passing ASTM E 136, Standard Test Method for Behavior of Materials in a Vertical Tube Furnace at 750 °C shall be considered non-combustible materials. An exception is made only for fire rated 5/8" Type X drywall UL authorized or equivalent. 5/8" Type X drywall may be used as a non-combustible material. For greater heat resistance, fireplace-specific cement boards like those produced by Promafour and Skamol are recommended in place of 5/8" Type X drywall.

Mantel Detail for Traditional Series

Maximum thickness of the mantel legs (indicated by the arrow in the upper diagram) is **2 inches**. You must provide a 1" clearance around the opening of the fireplace for every additional inch of thickness to the mantel legs.



LEGEND:

	Non-combustible material such as 5/8" Type X fire rated drywall (or equivalent)		Wood framing
	Section Cut		Metal framing

 The air flow area must be free from any obstruction to allow heat from the chase to be released.

Non-combustible material: Material which will not ignite and burn. Such materials are those consisting entirely of steel, iron, brick, tile, concrete, slate, glass or plasters, or any combination thereof. Materials that are reported as passing ASTM E 136, Standard Test Method for Behavior of Materials in a Vertical Tube Furnace at 750 °C shall be considered non-combustible materials. An exception is made only for fire rated 5/8" Type X drywall UL authorized or equivalent. 5/8" Type X drywall may be used as a non-combustible material. For greater heat resistance, fireplace-specific cement boards like those produced by Promafour and Skamol are recommended in place of 5/8" Type X drywall.

Ledge (Shelf) Detail

A ledge over the top of a fireplace that is less than 24" (48" for Traditional) from the top of the fireplace glass may require a heat release on top of the ledge if the surface area of the ledge exceeds the maximum allowable surface area as listed in the following table.

Model	Maximum Ledge Surface Area
Series 75	$A \times B \leq 220$ sq. in.
Series 90-130	$A \times B \leq 340$ sq. in.
Series 150-170	$A \times B \leq 410$ sq. in.
Series 200	$A \times B \leq 520$ sq. in.
Series 250	$A \times B \leq 580$ sq. in.

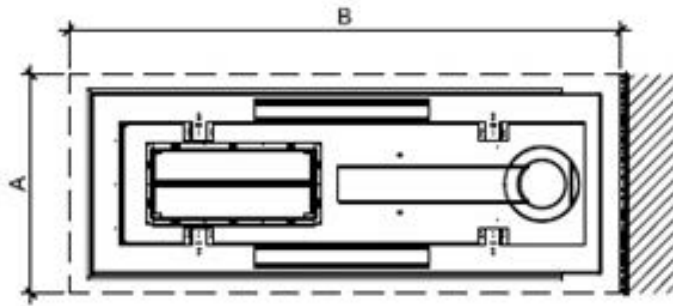

A = ledge depth, B= ledge width
(Plan View)

If your ledge exceeds the maximum allowable surface area, you will need to divide your heat release between the ledge and the chase ceiling: 25% in the ledge and 75% in the chase, as pictured in the following diagram (showing a Space Creator model as an example):

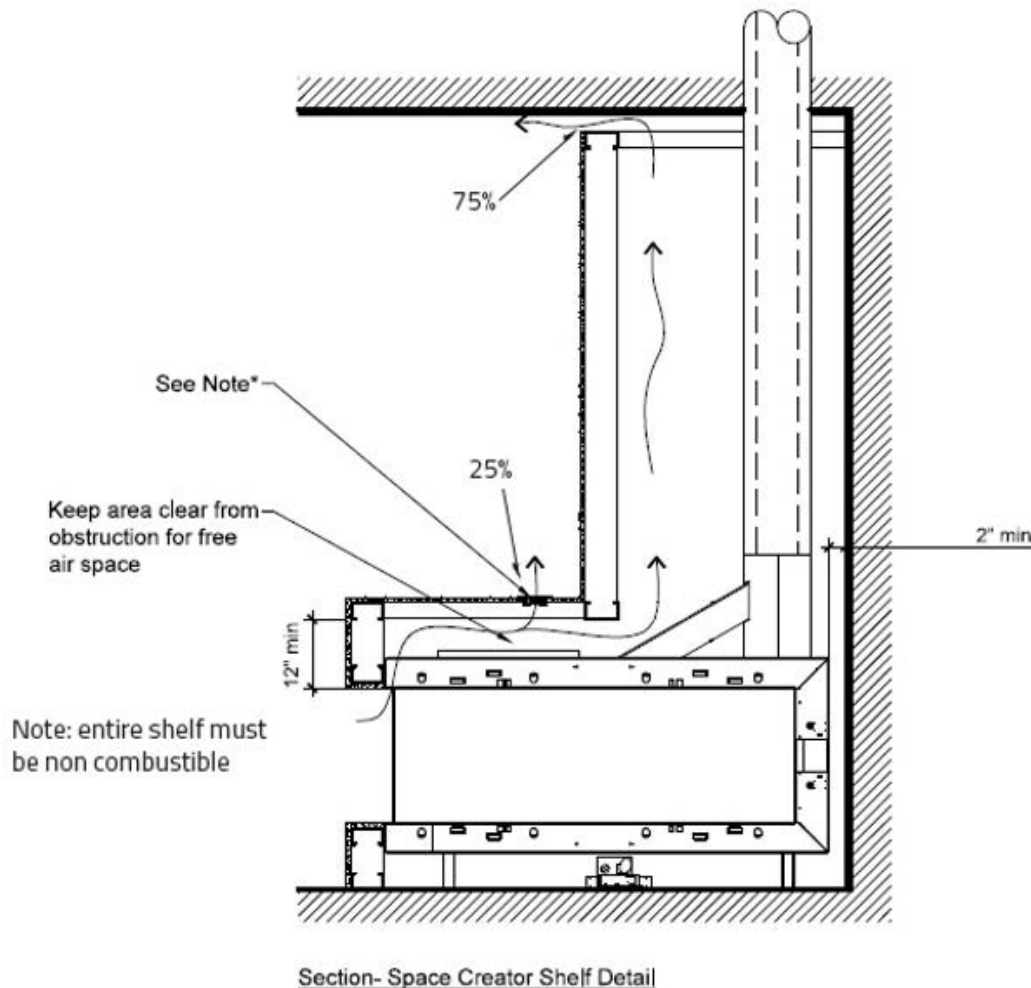

NOTE: Two layers of 5/8" Type X Drywall (or its equivalent) below the ledge will help keep the surface temperature down.

Chase Area Minimums

No part of the fireplace chase can have a smaller area than the required heat release size for your model (in square inches). See the section “Heat Release” to find your model’s minimum required heat release size.

To determine your chase size:

$$X = (L \times W) - (\pi r^2)$$

Where:

X = total chase area (in square inches)

L = chase length

W = chase width

πr^2 = the area of your pipe

$\pi = \sim 3.14156$ (a universal constant used when determining the area of a circle)

r = the radius of your pipe (which is half of the diameter)

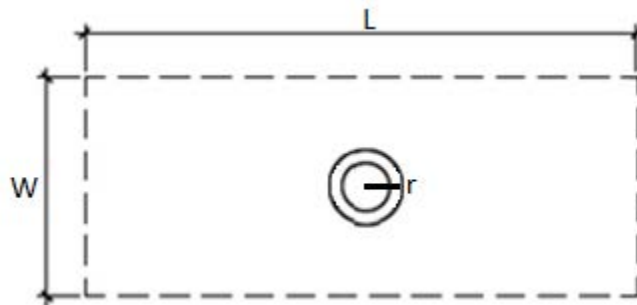

Fireplace Chase: Plan View

The size of the smallest part your chase should not be less than the size of your required heat release.

If your heat release is split into 25/75 portions due to an oversized ledge, your chase only needs to be the size of 75% of your heat release because 25% of the heat is already being released at the ledge (see the section “Ledge (Shelf) Detail” for more information).

Diagram for Structural Weight Support

ORTAL appliances must not carry any structural weight. The framing must be supported by another surface. Please consult with your structural engineer and refer to your local building codes for proper wall support.

The following drawing shows a recommended approach to this type of installation. Please note that this drawing is not to scale. All fireplace drawings with correct dimensions are available on our website.

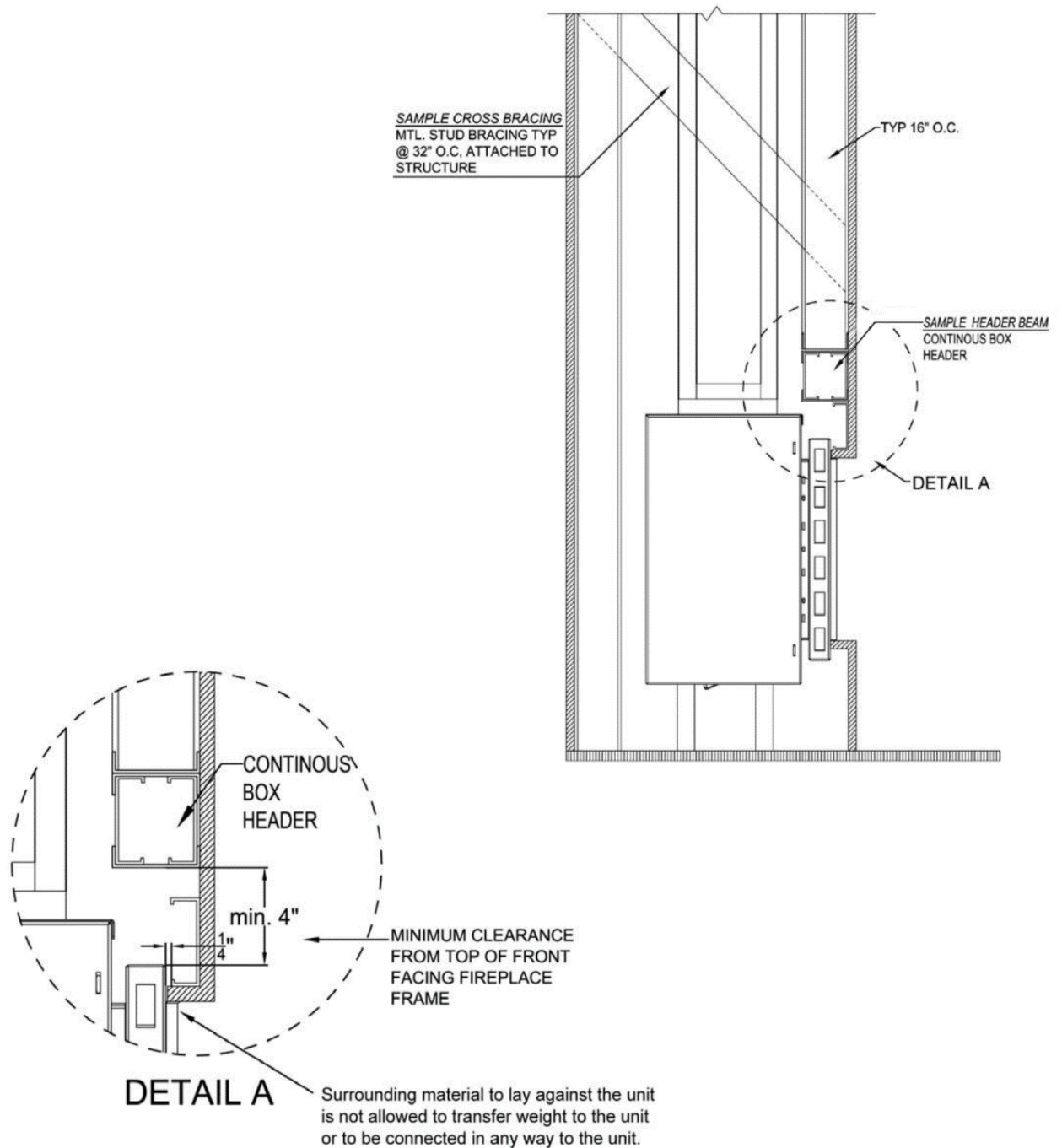

Gas Requirements and Setup

ORTAL appliances are sealed direct vent systems that can operate with natural gas (NG) or propane (LP). The following sections present detailed information about gas routing, pressures, and more.

Routing the Gas Line

Correctly size and route the gas supply line from the supply regulator to the area where the access panel is located (or to the burner area if no access panel is available – see diagram below), as per the requirements outlined in the latest edition of the National Fuel Gas Code, NFPA 54 (USA) or CAN/CSA-B1491 (Canada).

The gas and electrical components for all built-in models (except the Traditional series) are attached to the pilot on a flexible gas line and can be moved to any location within 36 inches of the pilot (which is located at the center front of the burner). Gas line should be routed to the access panel area (see “Access Panel” section for details). If no access panel is planned, gas line should be routed to most accessible area within 36 inches of the pilot.

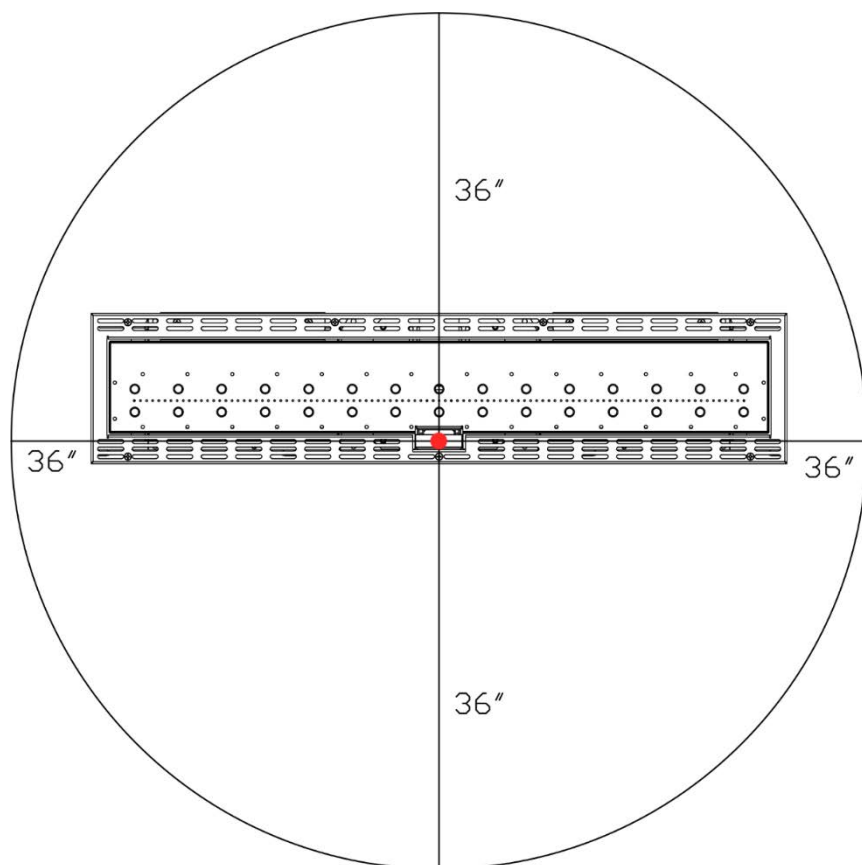

A gas shut-off valve and a 12" gas flex connector are provided with every ORTAL fireplace. The location of the gas shut-off valve is dependent on local codes and requirements. Check with your authority having jurisdiction for more information.

⚠ WARNING –The main gas valve must be installed to allow complete disconnection of the appliance from the gas supply piping system for servicing purposes.

Routing the Gas Line for Traditional Series

The gas and electrical components on a Traditional series ORTAL fireplace are located in a control box on the left side of the fireplace.

This control box houses the gas valve, a single gang outlet, and the electrical receiver. Route the gas line through cut out in the upper left side of the control box according to local codes and requirements. Check with your authority having jurisdiction for more information.



Gas/Electrical Components

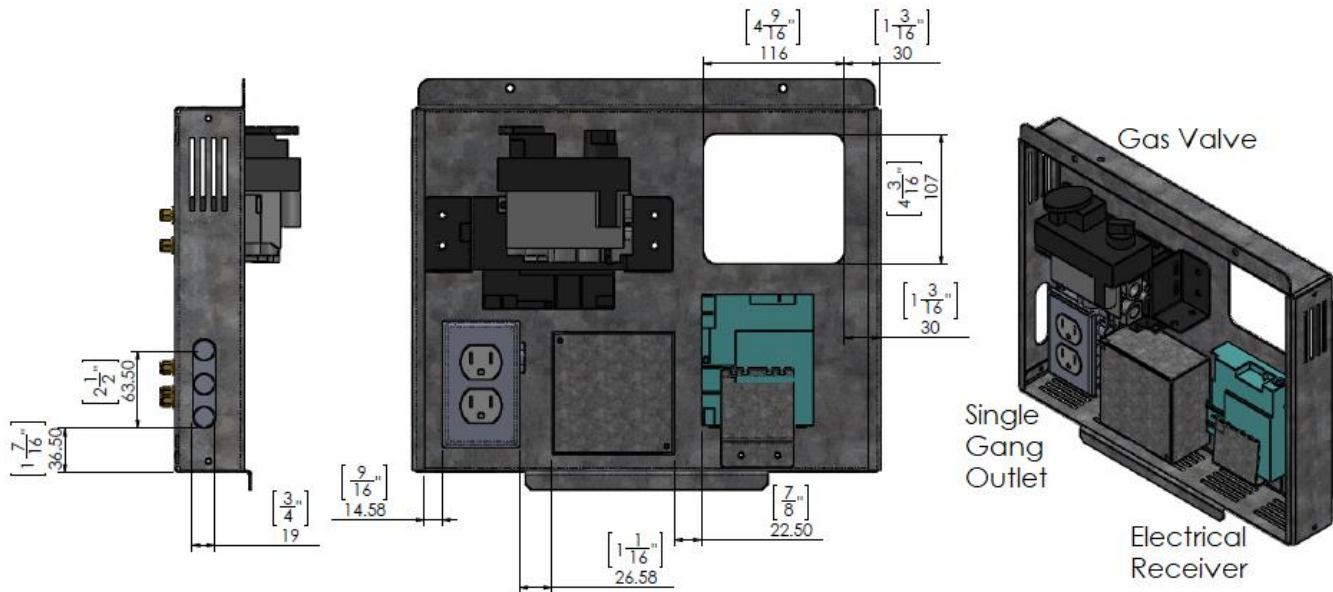

A gas shut-off valve and a 12" gas flex connector are provided with every ORTAL fireplace. The location of the gas shut-off valve is dependent on local codes and requirements. Check with your authority having jurisdiction for more information.

Gas Pressure and Heat Input Charts

The following table lists gas pressures and heat input values for models using the installation code **ANSI Z21.88/CSA 2.33** for *vented gas fireplace heaters*.

UNIT SERIES	BURNER	GAS TYPE	Inlet Pressures (Inch W.C.)		Manifold Pressures (Inch W.C.)		Heat Input BTU/hr		ORIFICE SIZE
			Min	Max	Min	Max	Min	Max	
40H70	30	Natural Gas (NG)	5.0	10.0	0.9	3.2	10,400	23,700	650
		Propane (LP)	11.0	13.0	0.9	10.9	12,800	21,000	220
60x80 75 75x65	45	Natural Gas (NG)	5.0	10.0	0.9	4.7	16,147	29,100	650
		Propane (LP)	11.0	13.0	0.9	10.7	13,811	22,118	220
110 120 130	100	Natural Gas (NG)	5.0	10.0	0.9	5	22,800	37,167	1200
		Propane (LP)	11.0	13.0	0.9	10.8	22,900	28,541	260
150 170	135	Natural Gas (NG)	5.0	10.0	0.9	3.5	23,300	43,715	1400
		Propane (LP)	11.0	13.0	0.9	10.7	27,100	36,850	380
200	160	Natural Gas (NG)	5.0	10.0	0.9	4.5	24,222	51,277	1400
		Propane (LP)	11.0	13.0	0.9	10.6	26,400	36,900	380
250	180	Natural Gas (NG)	5.0	10.0	0.9	4.7	21,7000	52,700	1400
		Propane (LP)	250 series is unavailable with propane.						

The following table lists gas pressures and heat input values for models using the installation code **ANSI Z21.50/CSA 2.22** for *decorative vented gas fireplaces*.

UNIT SERIES	BURNER	GAS TYPE	Inlet Pressures (Inch W.C.)		Manifold Pressures (Inch W.C.)		Heat Input BTU/hr		ORIFICE
			Min	Max	Min	Max	Min	Max	
Traditional	45D	Natural Gas (NG)	5.0	10.0	0.9	5.2	9,000	55,000	800R/650F
		Propane (LP)	Traditional series is unavailable with propane.						

High Altitude Gas Requirement

For elevations above 2,000 feet, appliance shall be re-rated 4% for each 1,000 feet above sea level.

Gas Control Assemblies and Components

Assemblies and components are listed and described in the tables following the figure.

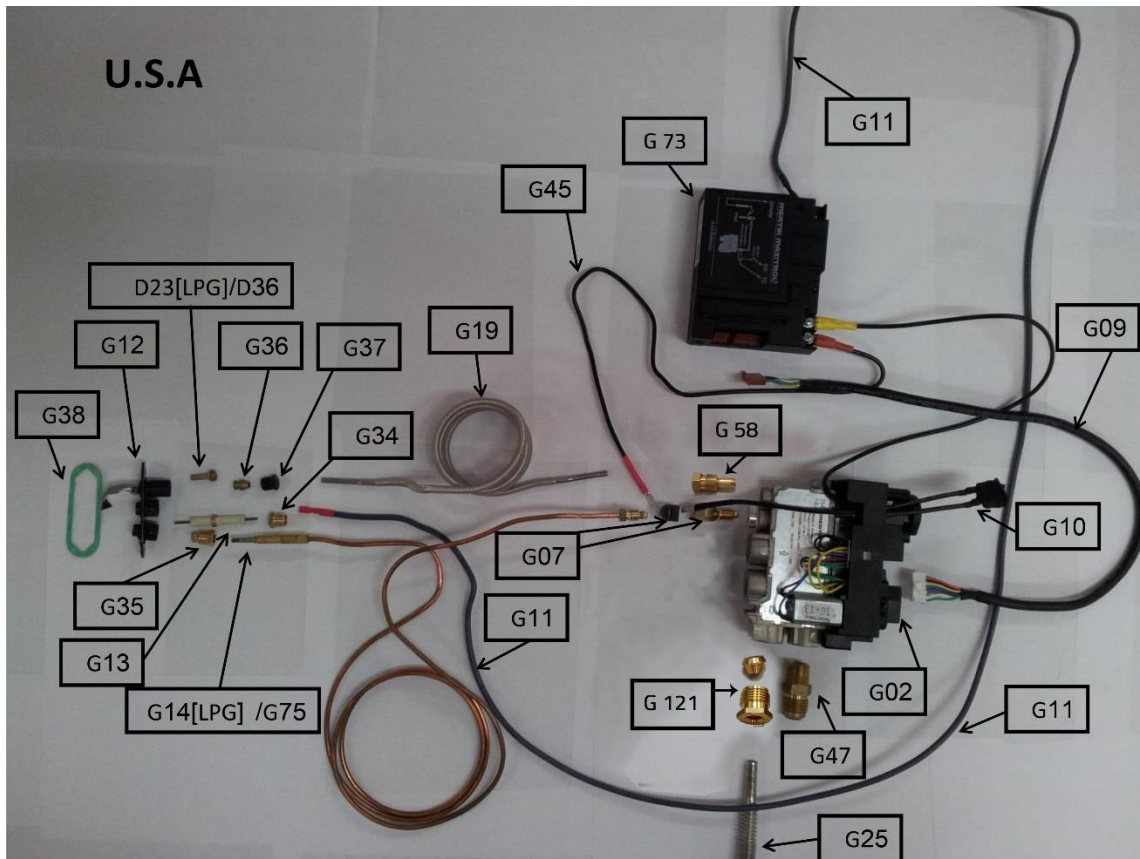

PART NUMBER	DESCRIPTION
D23	Propane pilot orifice
D36	Natural gas pilot orifice
G02	Mertik gas valve
G73	Mertik receiver
G07	Thermocouple block
G09	8-wire cable 500 mm
G10	Switch w cables 180/500 mm
G11	Spark wire
G12	Pilot
G13	Spark plug
G75	Thermocouple NG
G14	Thermocouple LPG

PART NUMBER	DESCRIPTION
G121	Main burner gas fitting
G25	Burner gas tube
G19	Pilot gas tube
G34	Spark plug connector
G35	TC connector
G36	Olive D.4
G37	Nut for olive D.4
G38	Gasket pilot burn
G45	Cable
G58	Connection fitting 4mm One-piece
G47	Fitting for main line inlet to gas valve GV60

The manufacturer of ORTAL's gas and electrical components is Mertik Maxitrol. For information on these components, please visit the manufacturer's website: www.mertikmaxitrol.com

Gas Conversion

Gas conversion (NG to LP or LP to NG) can be done in the field. Gas conversion can be performed only by technicians who have specific authorization by ORTAL to change these components. The conversion kit must be supplied by ORTAL. Using parts from other manufacturers or having an unauthorized party performing the conversion will void your appliance's warranty.

Pilot Inspection

The burner comes complete with all necessary parts assembled, including the air shutter, pilot orifice, pilot hood, thermocouple and spark plug. The parts are pre-set for the specific gas type (natural gas or propane), and no field adjustments are necessary at sea level. Elevations over sea level may require adjustments.

During start up and service, the pilot and its accessories must be inspected for cleanliness and completeness. Do **NOT** disassemble the components. The green pilot gasket must be replaced anytime the assembly is unscrewed.

Pilot Maintenance

- Remove the media and vacuum all debris from the firebox, burner and grill area at least once a year (quarterly for commercial installations).
- Visually inspect the pilot flame. The appearance should be candle-like with blue and yellow coloring. The pilot flame has two distinct flames. One engulfs the thermocouple, and the other reaches the main burner. Both flames must be present.
- The area around the pilot orifice should be inspected. Any foreign material must be removed with a brush or vacuum.



Pictured: Pilot Components (left to right: pilot, spark plug, thermocouple)



WARNING – For safety reasons, always be present when the fireplace is in operation.

Thermocouple Maintenance

Thermocouple integrity and operation must be checked. The service technician needs to confirm that the thermocouple is in place and is not cracked or damaged.

Electrical Guidelines

This chapter details electrical and wiring requirements for installation of ORTAL built-in fireplaces.

Electrical Requirements

With the exception of the Traditional series, a single gang outlet (120v 15-amp 60hz) must be provided in the location where the gas and electrical components will be placed, which must be within 36" of the pilot (see diagram in "Gas Requirements and Setup" for visual). An AC Adapter is provided with all ORTAL fireplaces to connect the electrical receiver to the outlet. Electrical work should be done by a qualified licensed electrician, per local code.

Electrical Requirements for Traditional Series

The gas and electrical components on a Traditional series ORTAL fireplace are located in a control box on the left side of the fireplace where a single gang outlet (120v 15-amp 60hz) is provided. See the section labelled "Routing the Gas Line for Traditional Series" for a visual. Electricity must be supplied to this outlet by a qualified licensed electrician, per local code. An AC Adapter is provided with all ORTAL fireplaces to connect the electrical receiver to the outlet.

 **WARNING** – Be sure to disconnect the power supply before servicing any electrical components.

Wiring Diagrams

The following diagrams show the electrical wiring required for different combinations of fireplace options.

Screen Unit

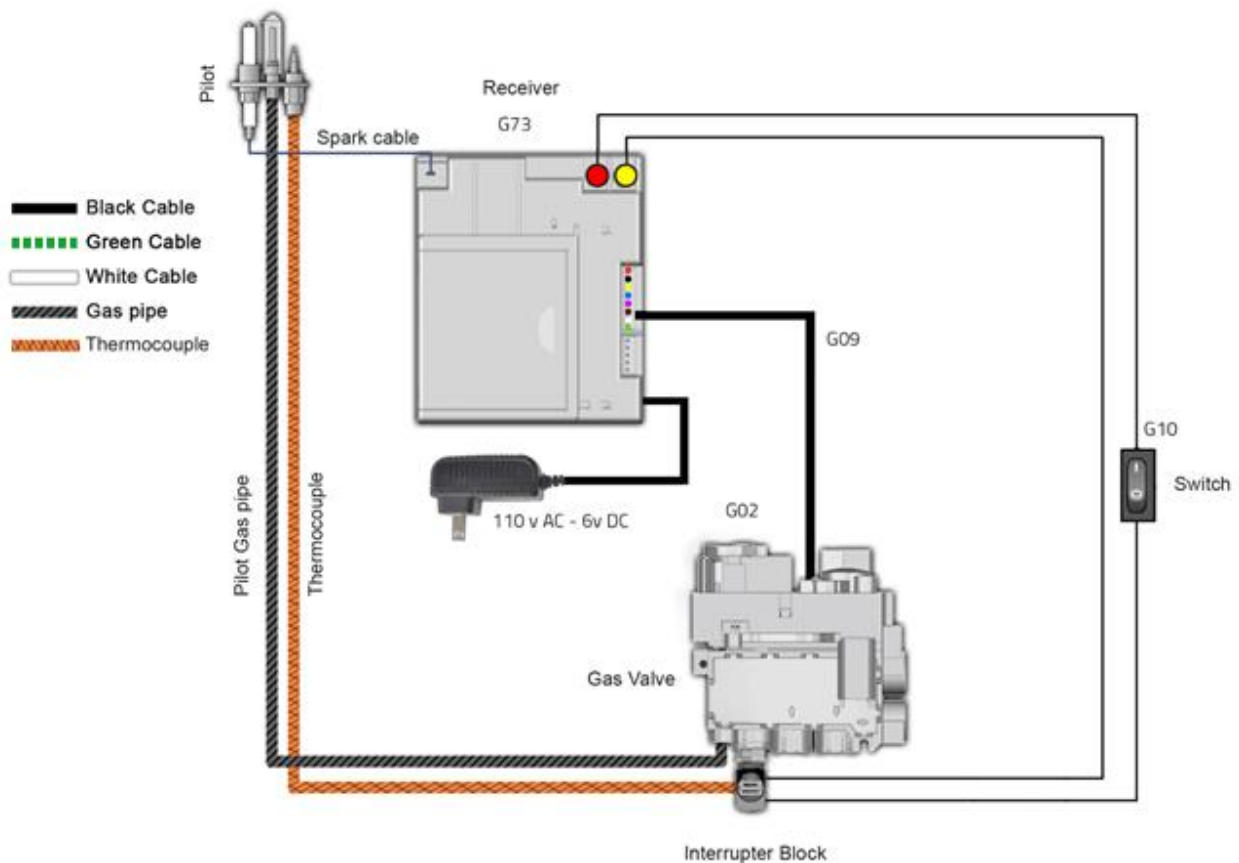

Screen Unit with Lights



NOTE: The fan outlet on the light control module is not used.

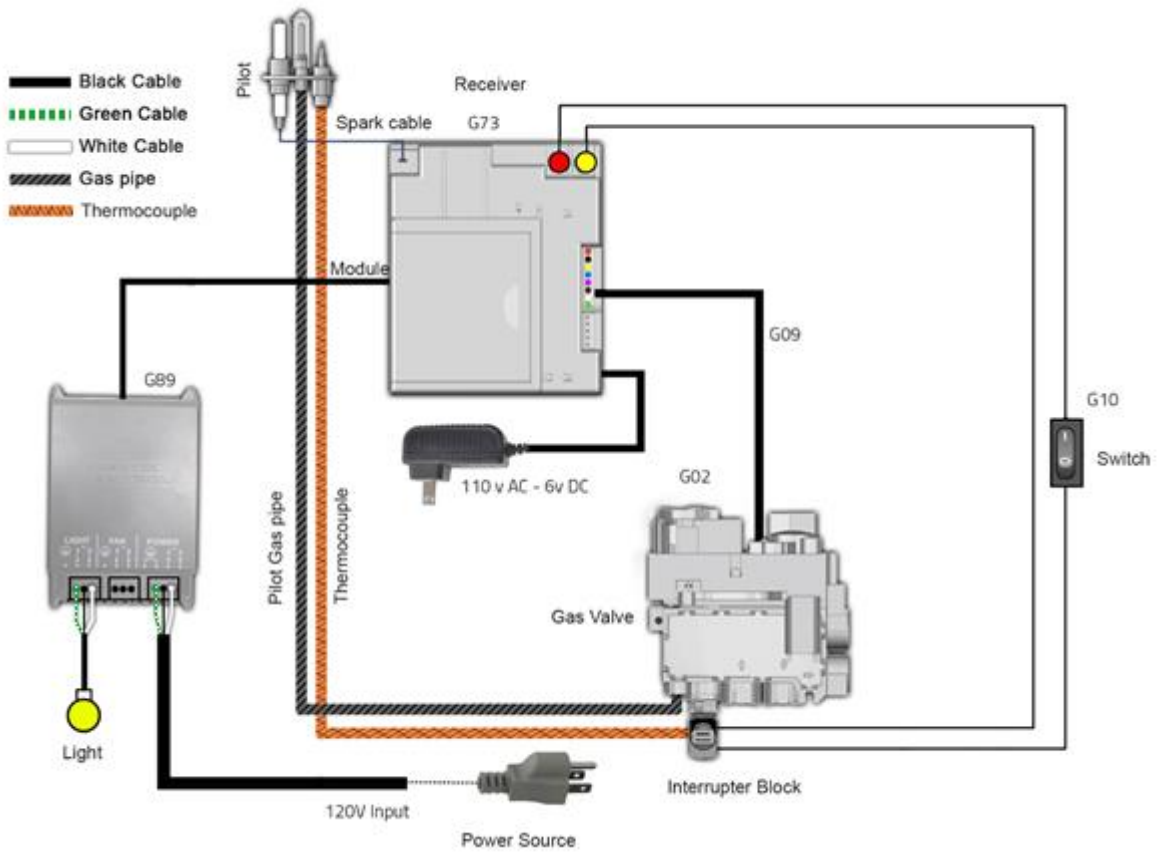

Screen Unit with ORTAL Power Vent

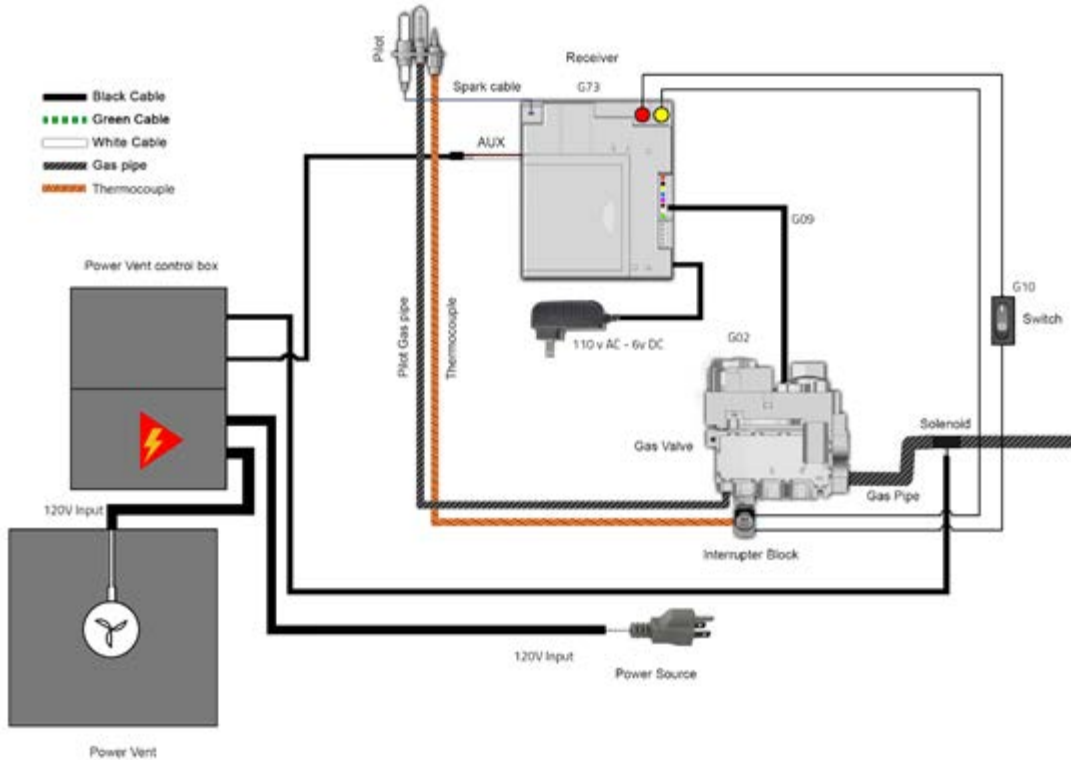

Screen Unit with ORTAL Power Vent and Lights

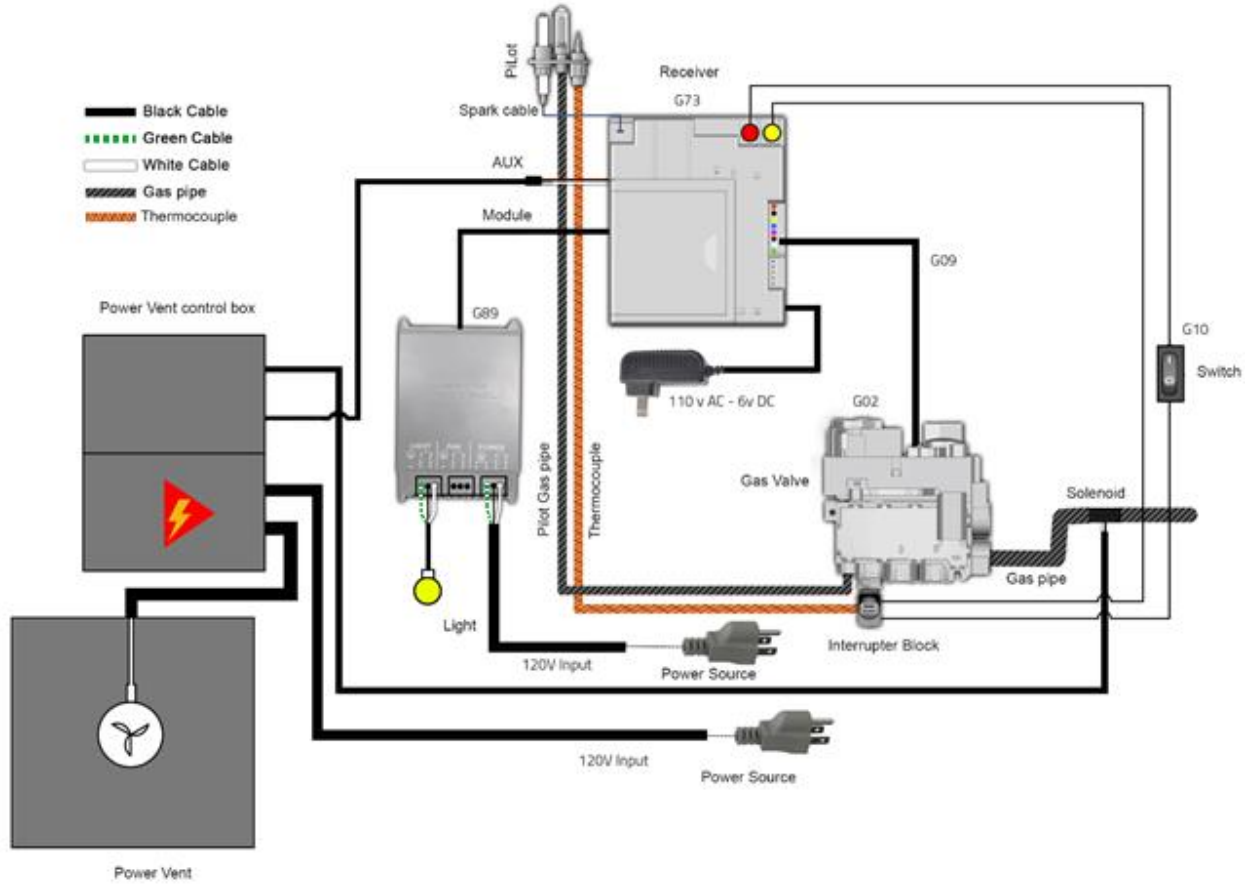

Screen Unit with Enervecx Power Vent

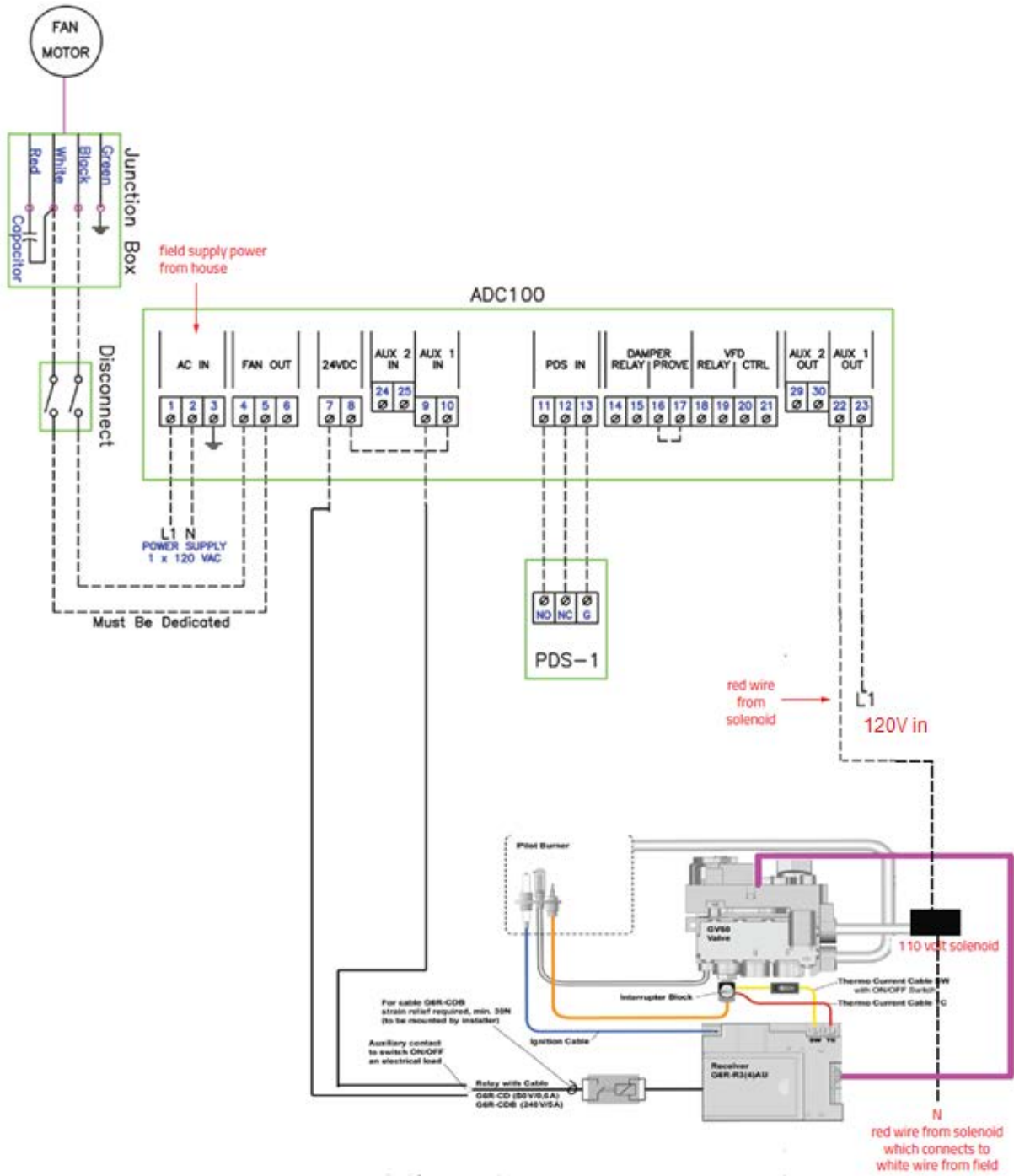

Double Glass Unit

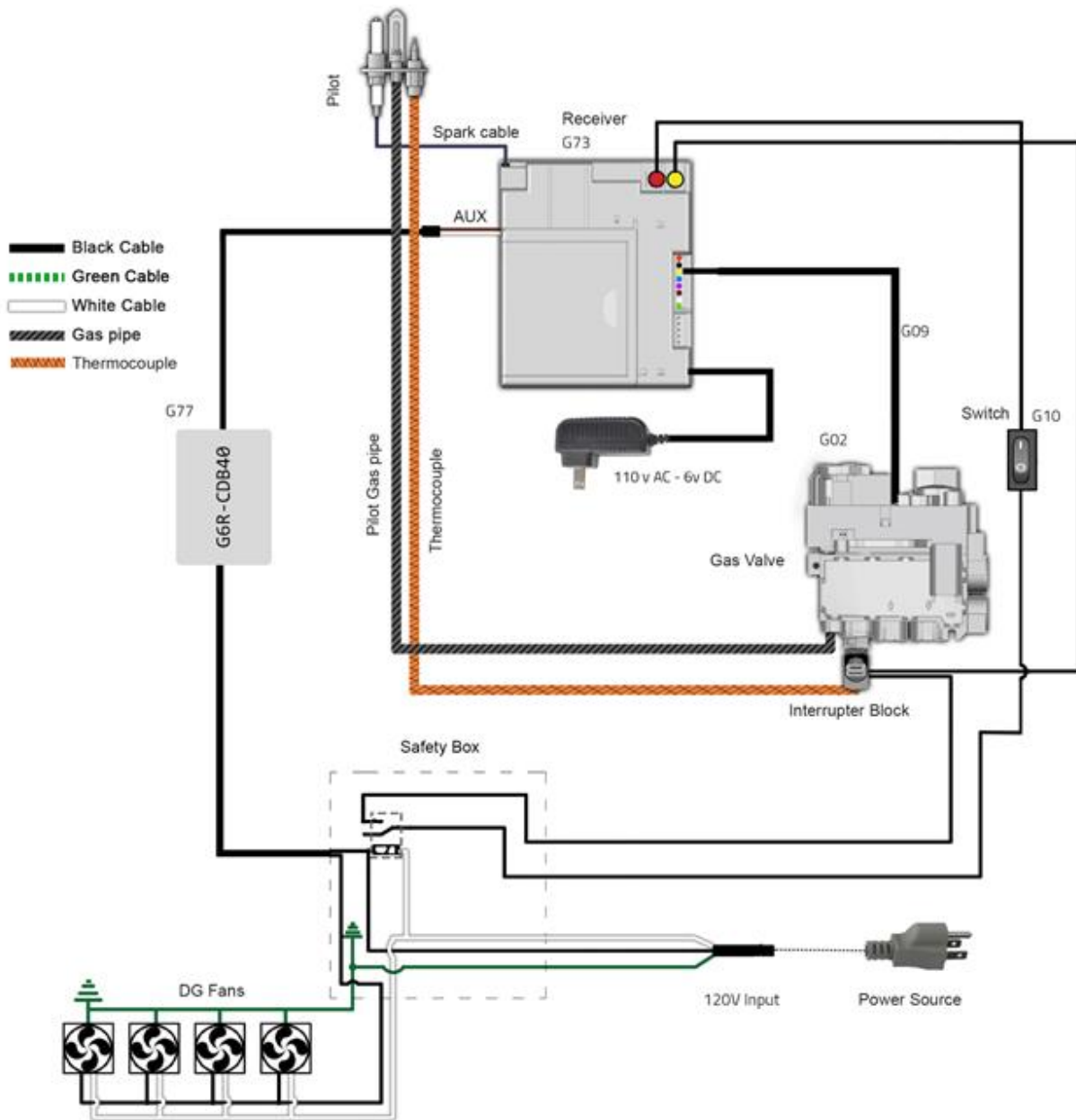

Double Glass Unit with Lights



NOTE: For an in-depth diagram of the safety box, refer to Safety Box Detail: Double Glass Units without Lights on page 51.

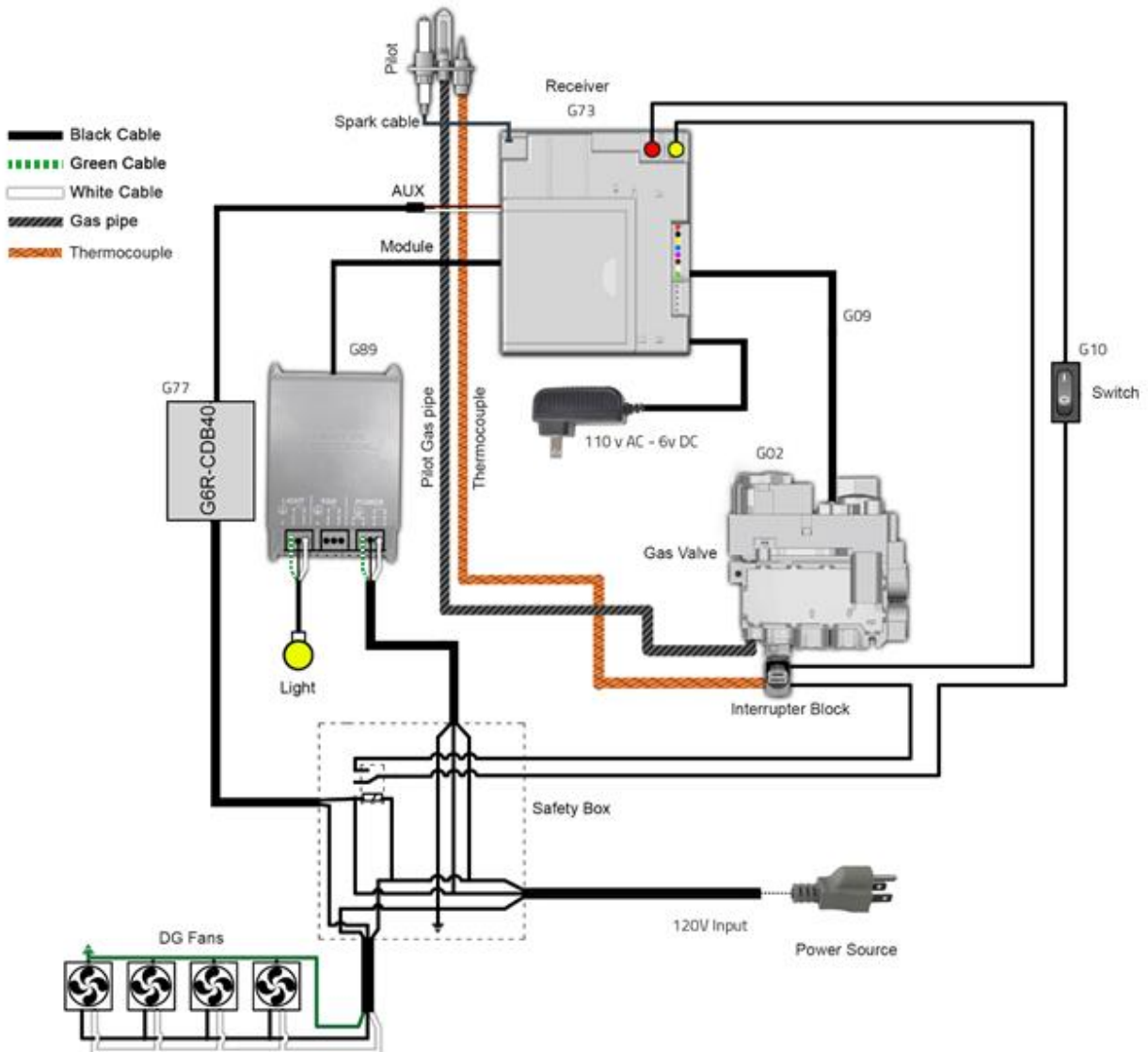

Double Glass Unit with ORTAL Power Vent



NOTE: For an in-depth diagram of the safety box, refer to Safety Box Diagram: Double Glass Units with Lights on page 51.

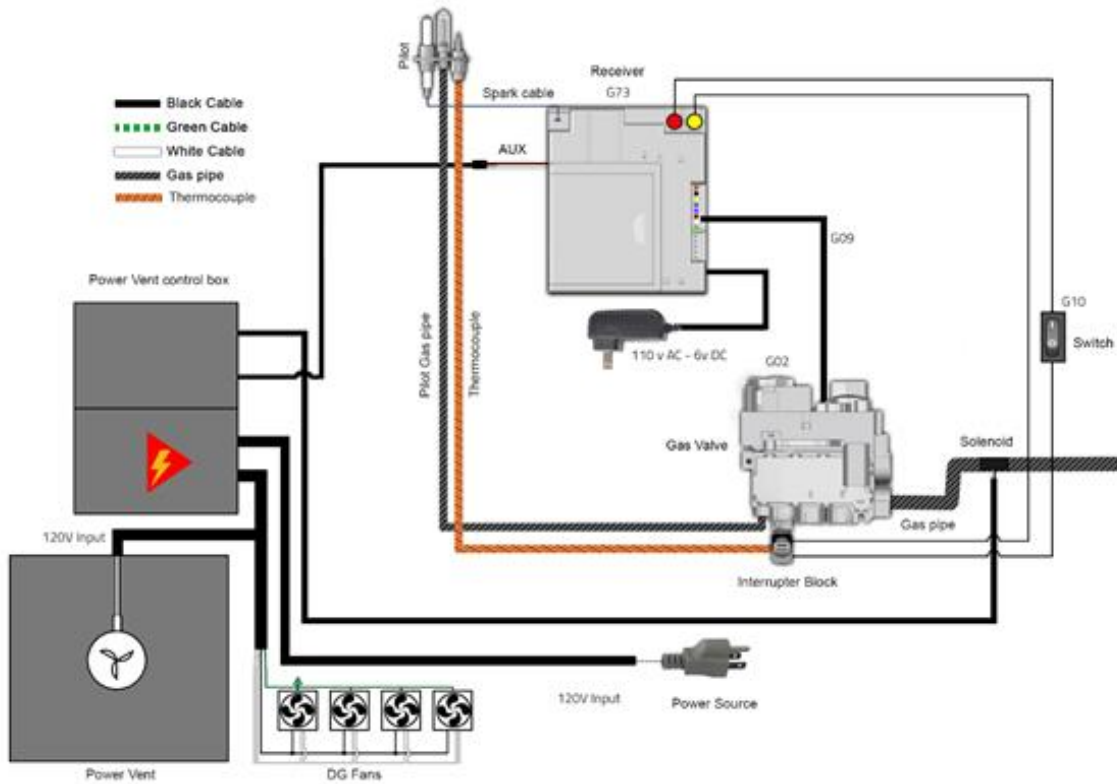

Double Glass Unit with ORTAL Power Vent and Lights

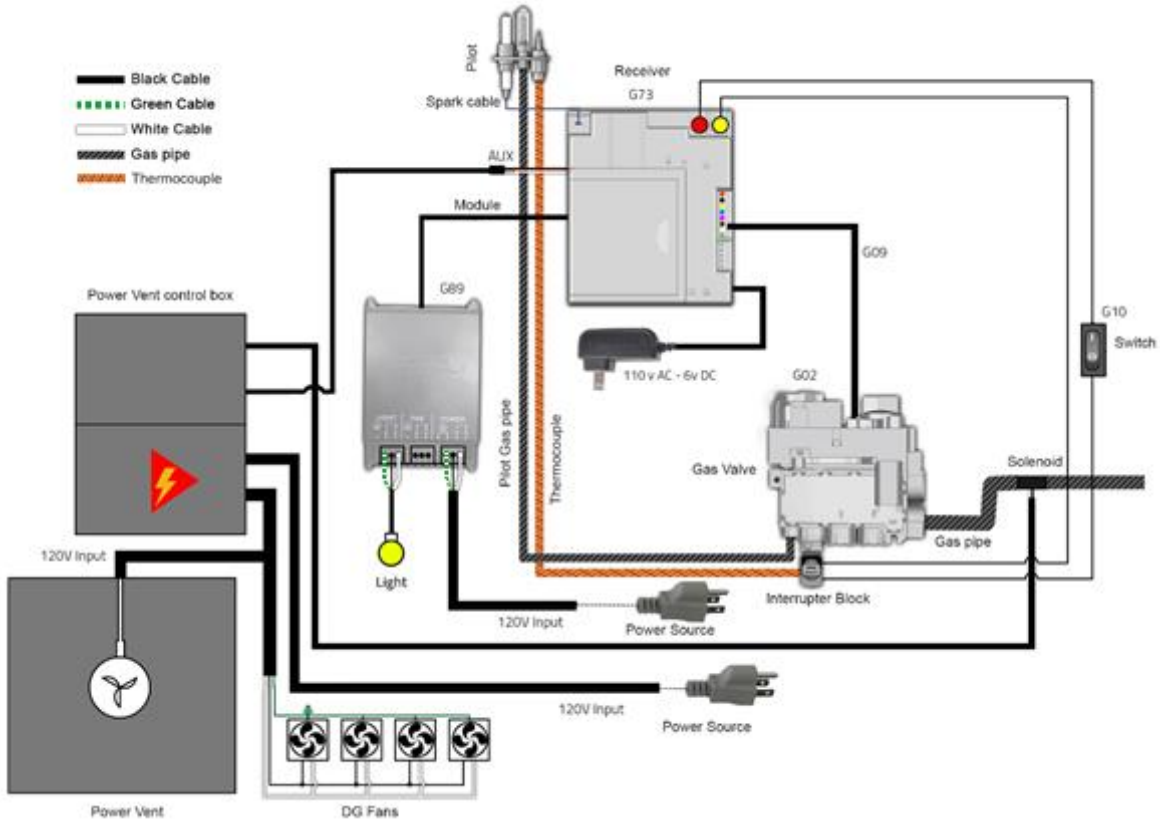

Double Glass Unit with Energex Power Vent

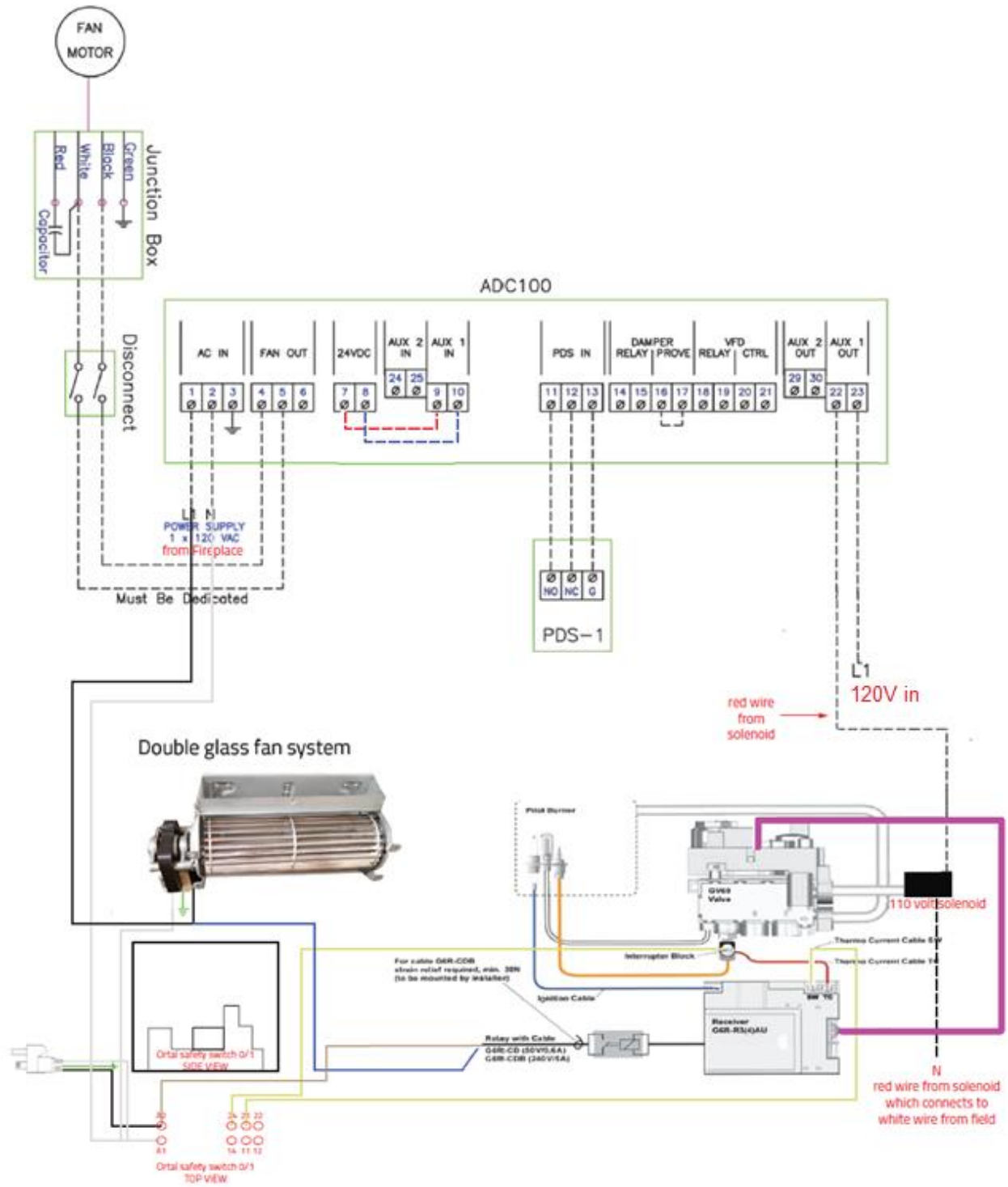

Safety Box Detail: Double Glass Unit without Lights

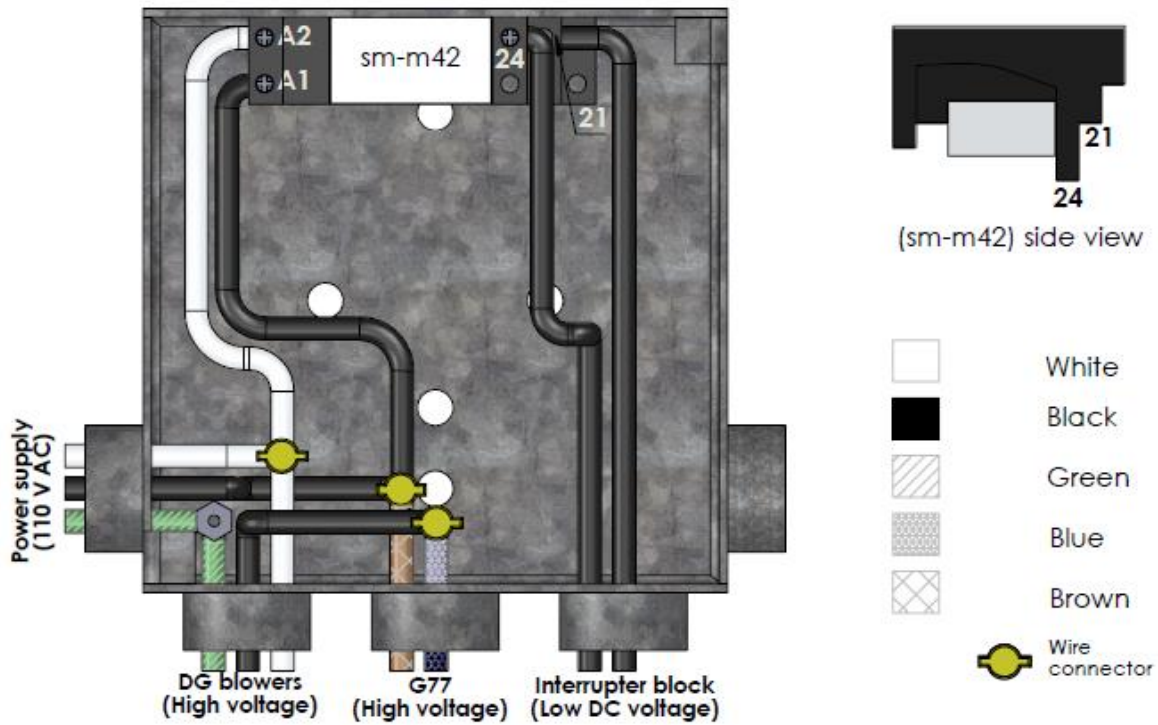

Safety Box Detail: Double Glass Units with Lights

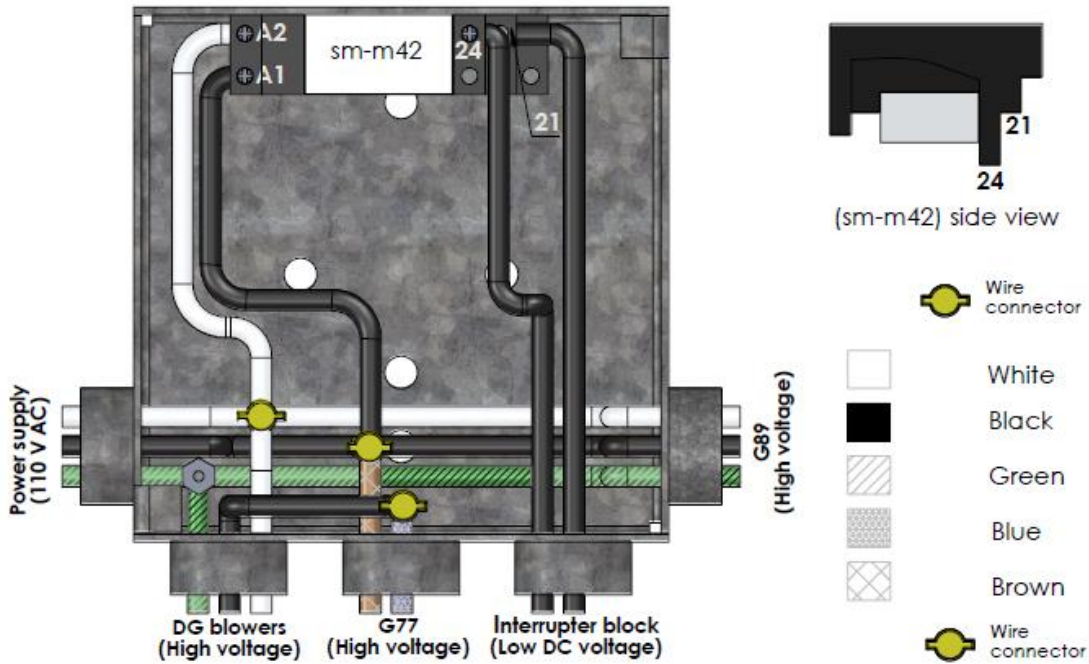

Smart Home System Wiring Information

The following wiring diagram is for incorporating fireplace control into a Smart Home System, taken from the Mertik Maxitrol operation guide:

MERTIK MAXITROL®

gV60 Remote electronic ignition and Control system external source operation



Contact Options/Operation

FOR OEM USE ONLY

⚠ WARNING

Fire or explosion hazard. Attempted disassembly or re-pair of controls can cause property damage, severe injury or death. Do not disassemble the gas valve; it contains no serviceable components.

Read these instructions carefully and completely before installing or operating. Failure to follow them could result in a fire or explosion causing property damage, personal injury, or loss of life. Service and installation must be performed by a trained/experienced service technician. The Mertik Maxitrol product should not be operated until it has been inspected and approved by the local code authority.

What to do if you smell gas:

- Do not operate any appliance.
- Do not touch any electrical switch; do not use any phone in your building.
- Immediately evacuate the area and contact the gas supplier. Follow the gas supplier's instructions.
- If you cannot reach the gas supplier, call the fire department.

Do NOT use this product if you suspect it has been subjected to high temperatures, damaged, tampered with, or taken apart.

Do NOT use a product if you suspect it has been under water or that liquid has seeped into the product. Any of these incidents can cause leakage or other damage that may affect proper operation and cause potentially dangerous combustion problems.

Do not store or use gasoline or other flammable vapors and liquids near this control or other appliances.

Use only your hand to push in or turn the gas control knobs. Never use tools. If a knob will not push in or turn by hand, do NOT try to repair it. Call a qualified service technician. Force or attempted repair can result in a fire or explosion.

Description

The GV60 will operate through an external source, such as a home automation system, by using the 5-wire pin connector on the receiver. A 1000 mm cable with Alex 2510-Z connector (part number G80-ZCE/1000) is available. The overall length of the cable should not exceed 8 m. Signal relays (gold contacts) or opto-couplers are recommended.

⚠ WARNING

It is the appliance manufacturer's responsibility to fully disclose any operation from a remote source that will create an unsafe operating condition. For Europe see GADAC guidance sheet B12.

Contacts Options/Operation

- **Ignition:** Close contact 1 and 3 simultaneously for 1 second.
- Fireplace automatically goes to high after ignition sequence.
- **UP FLAME:** Close contact 1. The contact needs to be closed for 12 seconds to turn the motor from end-stop to end-stop.
- **DOWN FLAME:** Close contact 3. The contact needs to be closed for 12 seconds to turn the motor from end-stop to end-stop.
- **Off:** Close contacts 1, 2, and 3 simultaneously for 1 second.

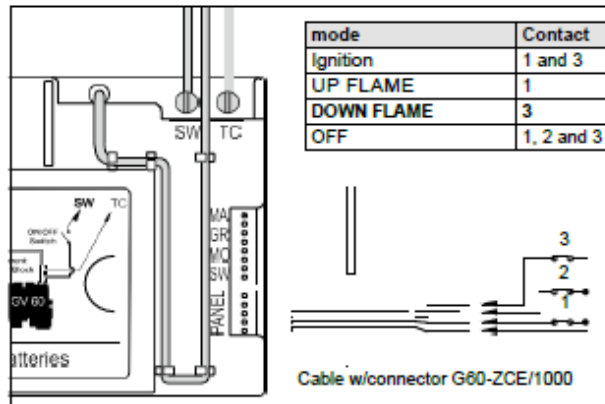

Figure 1: Wiring diagram and the operation sequence

Possible modes of Operation

Mode 1

The external source provides ON and OFF operation only. The Timer/Thermostat handset provides all other functions.

NOTICE

The Timer/Thermostat handset in Thermostatic Mode controls the room temperature even if the fire is turned on by the external source. If the handset is in Manual Mode, the fire will go to High Fire in the next cycle of external operation.

Mode 2

The external source controls the room temperature. The Timer/Thermostat handset must be set to Manual Mode (or use a standard handset). If the Timer/Thermostat handset is set to Thermostatic Mode, it will override the external source.

NOTICE

Frequent ON/OFF cycles will limit the life expectancy of the valve and will increase the battery consumption. The AC Mains Adapter may be used instead of batteries.

MERTIK MAXITROL®

Vent System Information

The following sections provide details related to vent pipe requirements and venting run details and diagrams.

General Pipe Requirements & Certified Pipe Manufacturers

ORTAL appliances operate using a direct vent system and require a co-axial direct vent pipe. ORTAL appliances must be properly connected to an approved vent system.

The pipe size required depends on the appliance size being specified:

Series 40-75 use 4x6 co-axial direct vent pipe (4-inch interior, 6-5/8"-inch exterior)

Series 90-250 use 5x8 co-axial direct vent pipe (5-inch interior, 8-inch exterior)

ORTAL is certified to be used with the following direct vent pipe manufacturers:

[Olympia: Ventis line](#)

[DuraVent: Direct Vent Pro line](#)

[ICC: EXCELDirect line](#)

[BDM: Pro-Form Direct Vent System line](#)

[Selkirk: Direct-Temp System line](#)

Proper installation, use and maintenance of pipe is determined by and can be acquired from the vent pipe manufacturer.

If the appliance is being power-vented (a fan-assisted direct vent system for venting runs that might not work on their own) with an ORTAL power vent, the unit will require **3x5 co-axial CVS pipe (3-inch interior, 5-inch exterior)** manufactured only by DuraVent (regardless of the appliance's size), called the [DuraVent: CVS line](#).

For units being power vented with an Enervex power vent, standard 4x6 or 5x8 pipe is required.



NOTE: See the ORTAL Power Vent Manual for more details on Power Venting.



WARNING – Do **NOT** combine vent components from different pipe manufacturers. Please follow the manufacturer's instructions for vent system installation.

Venting Requirements

When installing the venting, follow all instructions of the venting system manufacturer. For vertical and horizontal distances, refer to the charts in the Venting Diagrams section. Maintain all clearances specified in Vent Installation Clearances specified on the following pages. Alternatively, follow the vent system manufacturer's instructions, provided they meet local code.

Venting Installation and Clearances

The first section of venting must be secured to the starter with a minimum of 3 sheet metal screws no longer than 1/2". **DO NOT use silicone to seal the sections.** If sealing is required by the venting manufacturer or local code, use Mil-Pac sealant.

When installing the venting, be sure that the vent pipe is supported by the structural surrounding and not by the firebox. Secure the vent connection to the fireplace with a minimum of 3 self-tapping screws. Each elbow should be strapped to reduce movement or possible disconnection. Follow the installation instructions of the vent system manufacturer.

Vent Pipe Clearances

The following clearances apply to all pipe used with an ORTAL appliance, regardless of which pipe manufacturer is used.

Vertical Clearances:

Maintain 1" clearance to combustibles on entire circumference.

Horizontal Clearances:

Maintain 1" clearance to combustibles on bottom.

Maintain 3" clearance to combustibles on top. This clearance applies to pipe on a 45-degree angle as well.

Series	V Minimum (A)
40-170	3 ft
200-250	6 ft



NOTE: It is no longer required to maintain $\frac{1}{4}$ " of rise per foot of pipe.

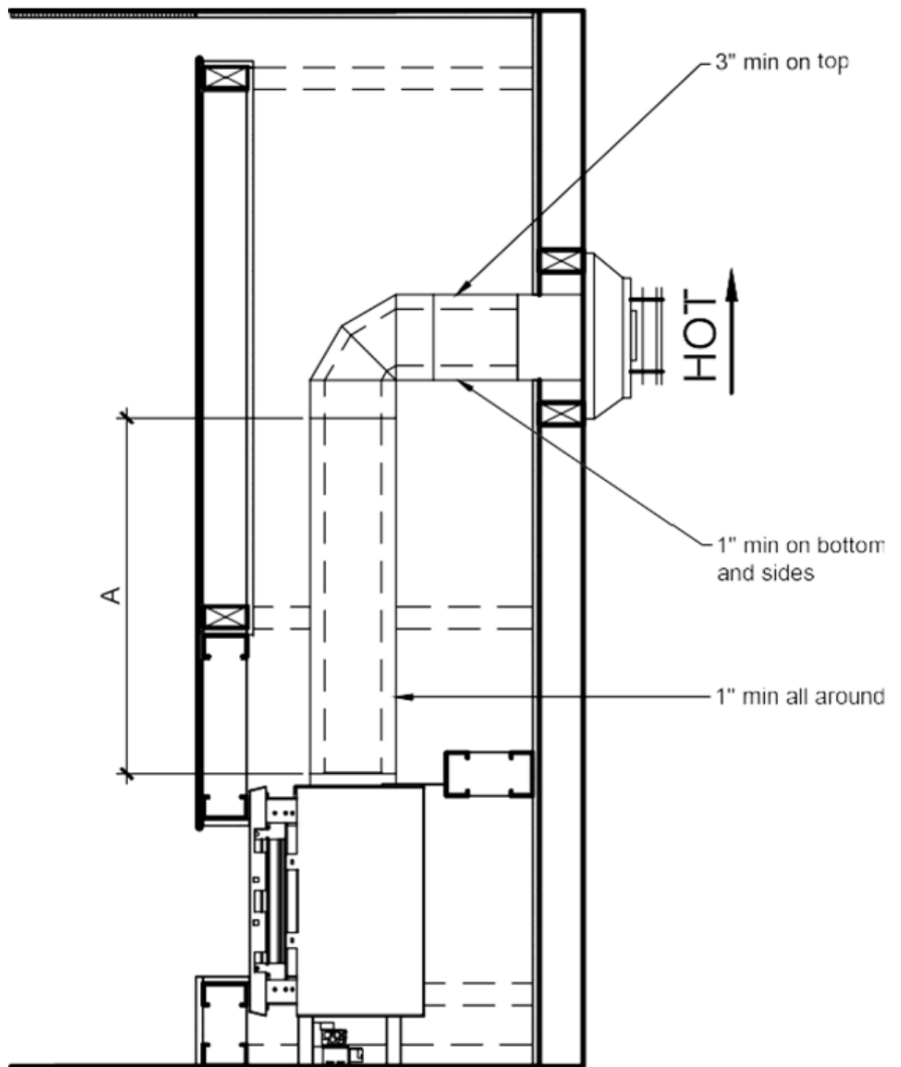

Venting Diagrams

The following sections provide information for calculating venting run distances. Use the diagram and tables below to calculate distances for venting runs.

Offset (bends/elbows) Maximums

Up to 180° of offset may be used in your venting run. This means either two 90° elbows, four 45° elbows, or any other combination thereof. If your venting run exceeds this maximum, consider an ORTAL Power Vent System, which can allow for up to 540° of offset. See the ORTAL Power Vent Manual for details.

Offset Maximum Exception:

If needed for clearance to TV recess, two 45° offsets may be used directly on the unit with up to a 12" section between them. The V minimum starts above them. They do not count in elbow totals.



NOTE: If your initial vertical rise off the top of the unit does not meet the V minimum, consider an ORTAL Power Vent System, which can allow for any initial vertical rise amount. See the ORTAL Power Vent Manual for details.

Horizontal Termination Venting Run Diagram

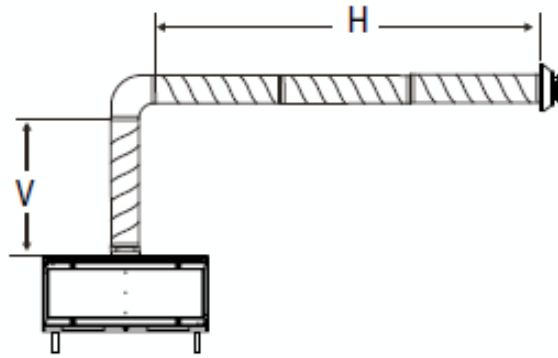

V= minimum 3 feet for series 40-170, minimum 6 feet for series 200-250.

Use this diagram and tables below to calculate distances for venting runs that terminate horizontally.

SERIES 40-75		SERIES 110-130		SERIES 150-170 & TRADITIONAL		SERIES 200-250	
Vertical (V)	Max Horizontal (H)	Vertical (V)	Max Horizontal (H)	Vertical (V)	Max Horizontal (H)	Vertical (V)	Max Horizontal (H)
3 ft	21 ft	3 ft	12 ft	3 ft	9 ft	-	-
6 ft	24 ft	6 ft	18 ft	6 ft	12 ft	6 ft	9 ft
9 ft	24 ft	9 ft	24 ft	9 ft	18 ft	9 ft	12 ft
12 ft	24 ft	12 ft	21 ft	12 ft	21 ft	12 ft	12 ft
15 ft	24 ft	15 ft	21 ft	15 ft	18 ft	15 ft	15 ft
18 ft	21 ft	18 ft	18 ft	18 ft	18 ft	18 ft	15 ft
21 ft	18 ft	21 ft	15 ft	21 ft	15 ft	21 ft	12 ft
24 ft	15 ft	24 ft	12 ft	24 ft	12 ft	24 ft	12 ft
27 ft	12 ft	27 ft	12 ft	27 ft	9 ft	27 ft	9 ft
30 ft	12 ft	30 ft	12 ft	30 ft	9 ft	30 ft	9 ft
33 ft	12 ft	33 ft	12 ft	33 ft	9 ft	33 ft	6 ft



NOTE: For venting runs that exceed these maximums, consider ORTAL's Power Vent System. See the ORTAL Power Vent Manual for details.

Vertical Termination Venting Run Diagram

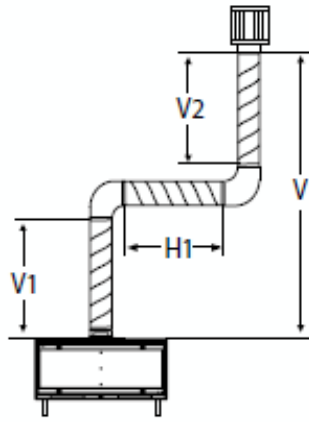

V1= minimum 3 feet for series 40-170, minimum 6 feet for series 200-250. $V = V1 + V2$

Use this diagram & tables below to calculate distances for venting runs that jog and terminate vertically.

SERIES 40-75	
Vertical (V)	Max Horizontal (H1)
3 ft	15 ft
7 ft	18 ft
10 ft	18 ft
13 ft	18 ft
16 ft	18 ft
19 ft	15 ft
22 ft	12 ft
25 ft	9 ft
28 ft	6 ft
31 ft	6 ft
34 ft	6 ft

SERIES 110-130	
Vertical (V)	Max Horizontal (H1)
3 ft	6 ft
7 ft	15 ft
10 ft	18 ft
13 ft	15 ft
16 ft	15 ft
19 ft	12 ft
22 ft	9 ft
25 ft	6 ft
28 ft	6 ft
31 ft	6 ft
34 ft	6 ft

SERIES 150-170 & TRADITIONAL	
Vertical (V)	Max Horizontal (H1)
3 ft	6 ft
7 ft	12 ft
10 ft	15 ft
13 ft	12 ft
16 ft	12 ft
19 ft	12 ft
22 ft	12 ft
25 ft	9 ft
28 ft	9 ft
31 ft	6 ft
34 ft	6 ft

SERIES 200-250	
Vertical (V)	Max Horizontal (H1)
-	-
6 ft	3 ft
10 ft	12 ft
13 ft	12 ft
16 ft	12 ft
19 ft	12 ft
22 ft	12 ft
25 ft	12 ft
28 ft	12 ft
31 ft	9 ft
34 ft	9 ft



NOTE: For venting runs that exceed these maximums, consider ORTAL's Power Vent System. See the ORTAL Power Vent Manual for details.

Vertical Termination Venting Run Diagram – Straight Vertical

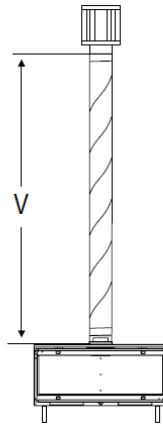

For Series 40-250, the maximum vertical distance is **42 feet**.



NOTE: For venting runs that exceed this maximum, consider ORTAL's Power Vent System. See the ORTAL Power Vent Manual for details.

Vent Restrictor Sizing Guidelines

SCENARIO A

When you have vertical elbows of 45°, no additional length for the (H) calculation for the restrictor plate size is needed. For example:

Total height of duct work = 6 feet (V)

Length between the center of the two 45° elbows = (B) = 3 feet

The (H) calculation is (H) = (B) so the restrictor plate size is 1.97", per the table.

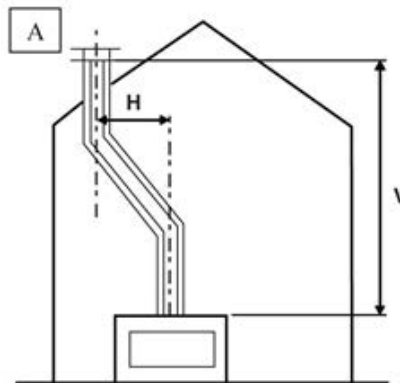

SCENARIO B

If there are two 90° elbows in the vent system, an additional 6 feet must be added to the (H) calculation for the restrictor plate size. For example:

Total height of duct work = 18 feet (V)

Length between the center of two 90° elbows = (B) = 21 feet

The (H) calculation to be used in the restrictor table is (H) = (B) + 6 feet, so the (H) length is 27 feet.

Per the table, the restrictor plate is 0. No restrictor is required.

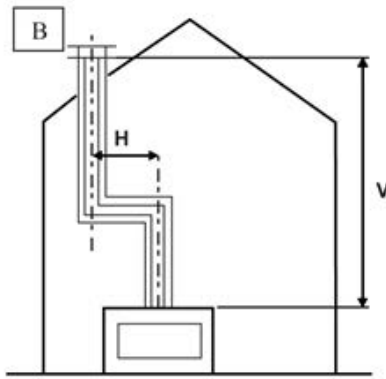

SCENARIO C

The first 90° elbow is not taken into calculation of the (H) length for the restrictor plate size. For example:
 Total height of duct work = 15 feet (V)
 Length between the center of the 90° elbow and wall termination cap = (B) = 11 feet
 The (H) calculation is (H) = (B) = 11. Therefore, the restrictor plate size is 1.18", per the table.
 The value of 11 does not appear on the x scale of the table. The choices are then 9 and 12. Always choose the next **higher** value, which is also the smaller restrictor if there is a difference between the values provided.

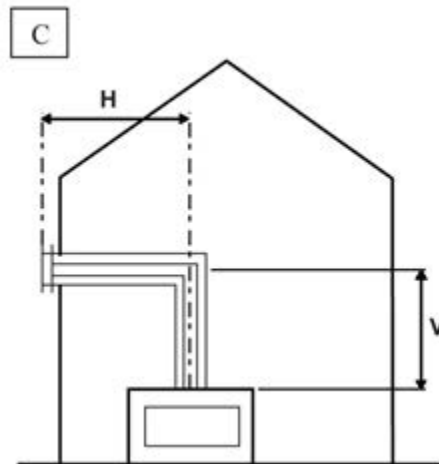

SCENARIO D

There are no 90° elbows or 45° angles. The venting is a straight vertical run. For example:
 Total height of duct work = 24 feet (V)
 The (H) calculation is = 0. Therefore, the restrictor plate size is 1.97".

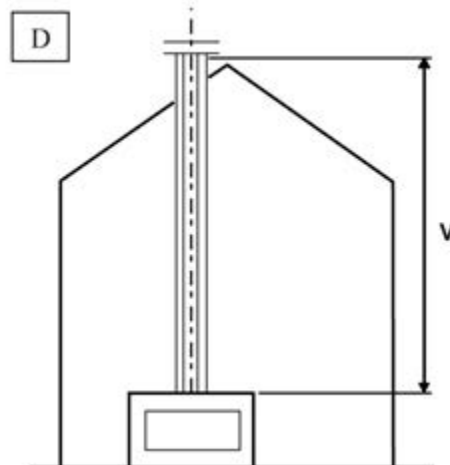

Fireplace Restrictors and Vent Arrangement

The information and tables in this section will help you calculate the correct restrictor selection. The tables below show the options permitted for both vertical and horizontal positioning of the pipe and the required restrictor. Any venting pathway that does not appear in the tables requires approval from the manufacturer.

The tables below apply to both Natural Gas and Propane. The tables represent manufacturer's guidelines. Environment gas type (NG vs. LP and the source of the gas) and other factors may affect the best restrictor choice.



NOTE: If the flame appears to be atypical, please contact ORTAL for alternate restrictor size recommendations.

The following symbols are used in the tables:

X: The path is not allowed.

0: There is no restriction.

Numbers other than zero: The number represents the width recommended for the size of restrictor.



NOTE: Space Creator models may require special restrictors. Traditional models do not require restrictors.

REMINDER

Series 40-170: A minimum 3' vertical run is required before any offset.

200-250: A minimum 6' vertical run is required before any 90° bends.

Restrictor Table: Series 40 (Burner 30)

V	0'	3'	6'	9'	12'	15'	18'	21'	24'	27'	30'	33'	H
27'	1.97"	1.57"	1.57"	1.18"	1.18"	0	0	0	0	x	x	x	
24'	1.97"	1.57"	1.57"	1.18"	1.18"	1.18"	0	0	0	0	X	x	
21'	1.97"	1.97"	1.57"	1.57"	1.18"	1.18"	1.18"	0	0	0	0	x	
18'	1.97"	1.97"	1.57"	1.57"	1.18"	1.18"	1.18"	1.18"	0	0	0	0	
15'	1.97"	1.97"	1.57"	1.57"	1.18"	1.18"	1.18"	1.18"	1.18"	0	0	0	
12'	1.97"	1.97"	1.57"	1.57"	1.57"	1.18"	1.18"	1.18"	1.18"	0	0	0	
9'	1.97"	1.97"	1.97"	1.57"	1.57"	1.18"	1.18"	1.18"	1.18"	0	0	0	
6'	1.97"	1.97"	1.97"	1.57"	1.57"	1.18"	1.18"	1.18"	1.18"	0	0	0	
3'	1.97"	1.97"	1.97"	1.57"	1.57"	1.18"	1.18"	1.18"	0	0	x	x	
1.5'	x	x	x	x	x	x	x	x	x	x	x	x	

Restrictor Table: Series 75 (Burner 45)

V	0'	3'	6'	9'	12'	15'	18'	21'	24'	27'	30'	33'	H
27'	1.97"	1.57"	1.57"	1.18"	1.18"	0	0	0	0	x	x	x	
24'	1.97"	1.57"	1.57"	1.18"	1.18"	1.18"	0	0	0	0	x	x	
21'	1.97"	1.97"	1.57"	1.57"	1.18"	1.18"	1.18"	0	0	0	0	x	
18'	1.97"	1.97"	1.57"	1.57"	1.18"	1.18"	1.18"	1.18"	0	0	0	0	
15'	1.97"	1.97"	1.57"	1.57"	1.18"	1.18"	1.18"	1.18"	1.18"	0	0	0	
12'	1.97"	1.97"	1.57"	1.57"	1.57"	1.18"	1.18"	1.18"	1.18"	0	0	0	
9'	1.97"	1.97"	1.97"	1.57"	1.57"	1.18"	1.18"	1.18"	1.18"	0	0	0	
6'	1.97"	1.97"	1.97"	1.57"	1.57"	1.18"	1.18"	1.18"	1.18"	0	0	0	
3'	1.97"	1.97"	1.97"	1.57"	1.57"	1.18"	1.18"	1.18"	0	0	x	x	
1.5'	x	x	x	x	x	x	x	x	x	x	x	x	

Restrictor Table: Series 110/130 (Burner 100)

V												
27'	1.97"	1.57"	1.57"	1.18"	1.18"	0	0	x	x	x	x	x
24'	1.97"	1.57"	1.57"	1.18"	1.18"	0	0	0	x	x	x	x
21'	1.97"	1.97"	1.57"	1.57"	1.18"	1.18"	0	0	0	x	x	x
18'	1.97"	1.97"	1.97"	1.57"	1.57"	1.18"	1.18"	0	0	0	x	x
15'	1.97"	1.97"	1.97"	1.57"	1.57"	1.18"	1.18"	1.18"	0	0	0	x
12'	1.97"	1.97"	1.97"	1.57"	1.57"	1.18"	1.18"	1.18"	0	0	0	x
9'	1.97"	1.97"	1.97"	1.57"	1.57"	1.57"	1.18"	1.18"	0	0	0	x
6'	1.97"	1.97"	1.97"	1.57"	1.57"	1.18"	1.18"	1.18"	0	0	x	x
3'	1.97"	1.97"	1.97"	1.57"	1.18"	0	0	0	0	x	x	x
1.5'	x	x	x	x	x	x	x	x	x	x	x	x
	0'	3'	6'	9'	12'	15'	18'	21'	24'	27'	30'	33'

H

Restrictor Table: Series 150/170 (Burner 135)

V												
27'	1.97"	1.57"	1.57"	1.18"	1.18"	1.18"	0	0	x	x	x	x
24'	1.97"	1.57"	1.57"	1.18"	1.18"	1.18"	0	0	0	X	x	x
21'	1.97"	1.57"	1.57"	1.18"	1.18"	1.18"	1.18"	0	0	0	x	X
18'	1.97"	1.57"	1.57"	1.57"	1.18"	1.18"	1.18"	0	0	0	0	X
15'	2.76"	1.97"	1.57"	1.57"	1.57"	1.18"	1.18"	0	0	0	0	0
12'	2.76"	1.97"	1.57"	1.57"	1.18"	1.18"	1.18"	0	0	0	0	0
9'	2.76"	1.97"	1.57"	1.57"	1.18"	1.18"	1.18"	0	0	0	0	0
6'	2.76"	1.97"	1.97"	1.57"	1.18"	1.18"	1.18"	0	0	0	0	x
3'	1.97"	1.97"	1.97"	1.57"	1.18"	1.18"	1.18"	0	0	x	X	x
1.5'	x	x	x	x	x	x	x	x	x	x	x	x
	0'	3'	6'	9'	12'	15'	18'	21'	24'	27'	30'	33'

H

Restrictor Table: Series 200 (Burner 160)

V												
27'	1.97"	1.57"	1.57"	1.18"	1.18"	0	0	0	0	x	x	x
24'	1.97"	1.57"	1.57"	1.18"	1.18"	0	0	0	0	x	x	x
21'	1.97"	1.97"	1.57"	1.18"	1.18"	0	0	0	0	x	x	x
18'	1.97"	1.97"	1.57"	1.18"	1.18"	0	0	0	0	x	x	x
15'	1.97"	1.97"	1.57"	1.18"	1.18"	0	0	0	x	x	x	x
12'	1.97"	1.97"	1.57"	1.18"	1.18"	0	0	0	x	x	x	x
9'	1.97"	1.97"	1.57"	1.18"	1.18"	0	0	0	x	x	x	x
6'	1.97"	1.57"	1.57"	1.18"	0	0	0	x	x	x	x	x
3'	x	x	x	x	x	x	x	x	x	x	x	x
1.5'	x	x	x	x	x	x	x	x	x	x	x	x
	0'	3'	6'	9'	12'	15'	18'	21'	24'	27'	30'	33'

H

Restrictor Table: Series 250 (Burner 180)

V												
15'	1.97"	1.97"	1.57"	1.18"	1.18"	0	0	0	x	x	x	x
12'	1.97"	1.97"	1.57"	1.18"	1.18"	0	0	0	x	x	x	x
9'	1.97"	1.97"	1.57"	1.18"	1.18"	0	0	0	x	x	x	x
6'	1.97"	1.57"	1.57"	1.18"	0	0	0	x	x	x	x	x
3'	x	x	x	x	x	x	x	x	x	x	x	x
1.5'	x	x	x	x	x	x	x	x	x	x	x	x
	0'	3'	6'	9'	12'	15'	18'	21'	24'	27'	30'	33'

H

Horizontal Termination Clearance Diagrams

V = VENT TERMINAL **X** = AIR SUPPLY INLET = AREA WHERE TERMINAL IS NOT PERMITTED

A = 12 inches.....clearances above grade, veranda, porch, deck or balcony
(See Note 1)

B = 12 inches.....clearances to window or door that may be opened, or to permanently closed window. (Glass)

C = 24 inches.....vertical clearance to unventilated soffit or to ventilated soffit located above the terminal
42 inches.....for vinyl clad soffits and below electrical service

D = 9 inches.....clearance to outside corner

E = 6 inches.....clearance to inside corner

F = 3 ft. (Canada).....not to be installed above a gas meter/regulator assembly within 3 feet (90 cm) horizontally from the center-line of the regulator

G = 3 ft.....clearance to gas service regulator vent outlet

H = 9 inches (U.S.A.)
12 inches (Canada).....clearance to non-mechanical air supply inlet to building or the combustion air inlet to any other appliance

i = 3 ft. (U.S.A.)
6 ft. (Canada).....clearance to a mechanical (powered) air supply inlet

J** = 7 ft.....clearance above paved sidewalk or a paved driveway located on **public** property
(See Note 1)

K = 6 inches.....clearance from sides of electrical service
(See Note 5)

L = 12 inches.....clearance above electrical service
(See Note 5)

Covered Alcove Applications

M*** = 18 inches.....clearance under veranda, porch, deck, balcony or overhang
42 inches.....vinyl

N = 6 inches.....non-vinyl sidewalls
12 inches.....vinyl sidewalls

O = 18 inches.....non-vinyl soffit and overhang
42 inches.....vinyl soffit and overhang

P = 8 ft.

	Q_{MIN}	R_{MAX}
1 cap	3 feet	$2 \times Q_{ACTUAL}$
2 caps	6 feet	$1 \times Q_{ACTUAL}$
3 caps	9 feet	$2/3 \times Q_{ACTUAL}$
4 caps	12 feet	$1/2 \times Q_{ACTUAL}$
$Q_{MIN} = \# \text{ termination caps} \times 3$ $R_{MAX} = (2 / \# \text{ termination caps}) \times Q_{ACTUAL}$		

Note 1: On private property where termination is less than 7 feet above a sidewalk, driveway, deck, porch, veranda or balcony, use of a listed cap shield is suggested. (See vents components page)

Note 2: Termination in a covered alcove space (spaces open only on one side and with an overhang) are permitted with the dimensions specified for vinyl or non vinyl siding and soffits. 1. There must be 3 feet minimum between termination caps. 2. All mechanical air intakes within 10 feet of a termination cap must be a minimum of 3 feet below the termination cap. 3. All gravity air intakes within 3 feet of a termination cap must be a minimum of 1 foot below the termination cap.

Note 3: Local codes or regulations may require different clearances.

Note 4: Termination caps may be hot. Consider their proximity to doors or other traffic areas.

Note 5: Location of the vent termination must not interfere with access to the electrical service.

In the U.S and Canada: Vent system termination is **NOT** permitted in screened porches.

Vent system termination is permitted in porch areas with two or more sides open. You must follow all side walls, overhang and ground clearances as stated in the instructions.

For vertical terminations:

1. Keep minimum of 2 feet between vent terminations.
2. Maintain a minimum of 2 feet clearance between edge of vertical termination and perpendicular wall.
3. If terminating near window, keep minimum of 2 feet clearance between window and vent termination.

CAUTION: IF EXTERIOR WALLS ARE FINISHED WITH VINYL SIDING, IT IS SUGGESTED THAT A VINYL PROTECTOR KIT BE INSTALLED.

Vertical Termination Clearance Diagrams

⚠ WARNING



Fire Risk.
Maintain vent clearance to combustibles as specified.

- **DO NOT** pack air space with insulation or other materials.

Failure to keep insulation or other materials away from vent pipe may cause overheating and fire.

Minimum Height From Roof To Lowest Discharge Opening

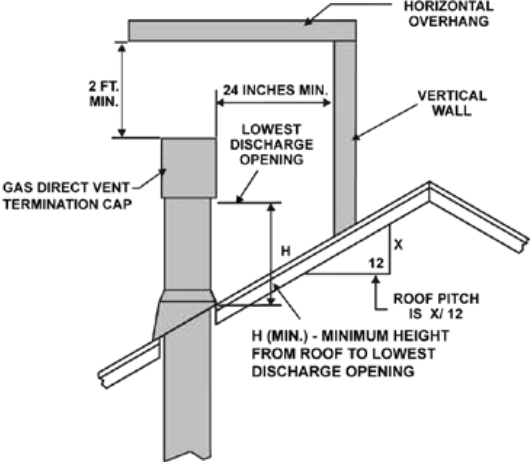

Roof Pitch	H (Min.) Ft.
Flat to 6/12.....	1.0*
Over 6/12 to 7/12.....	1.25*
Over 7/12 to 8/12.....	1.5*
Over 8/12 to 9/12.....	2.0*
Over 9/12 to 10/12.....	2.5*
Over 10/12 to 11/12.....	3.25
Over 11/12 to 12/12.....	4.0
Over 12/12 to 14/12.....	5.0
Over 14/12 to 16/12.....	6.0
Over 16/12 to 18/12.....	7.0
Over 18/12 to 20/12.....	7.5
Over 20/12 to 21/12.....	8.0

* 3 foot minimum in snow regions

Staggered Termination Caps

A	B
6 in. (minimum) up to 24 in.	18 in. minimum
24 in. and over	0 in. minimum

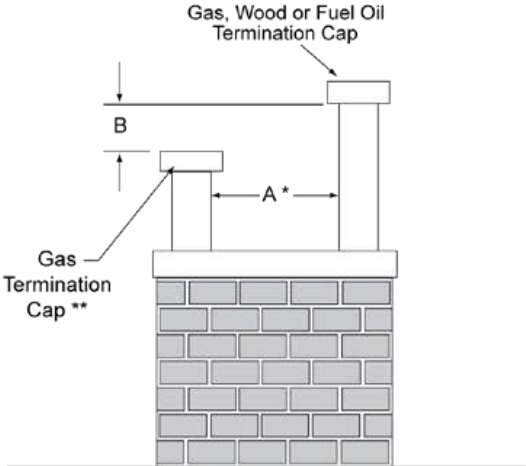

* If using decorative cap cover(s), this distance may need to be increased. Refer to the installation instructions supplied with the decorative cap cover.

** In a staggered installation with both gas and wood or fuel oil terminations, the wood or fuel oil termination cap must be higher than the gas termination cap.

- Notes:**
1. Maintain a minimum of 2 feet clearance between edge of vertical termination and perpendicular wall.
 2. If terminating near window, keep minimum of 2 feet clearance between window and vent termination.
 3. All mechanical air intakes within 10 feet of a termination cap must be a minimum of 3 feet below the termination cap.
 4. All gravity air intakes within 3 feet of a termination cap must be a minimum of 1 foot below the termination cap.



NOTE: This chart does not apply to a chimney shroud application. See Chimney Shroud Detail on the next page for more information.

Chimney Shroud Detail

Keep a minimum 6-inch clearance around the vent termination to surrounding. This includes the bottom side of termination as well.

If the top of the shroud is enclosed, keep a maximum of 10 inches clear from the top of the termination to the shroud ceiling.

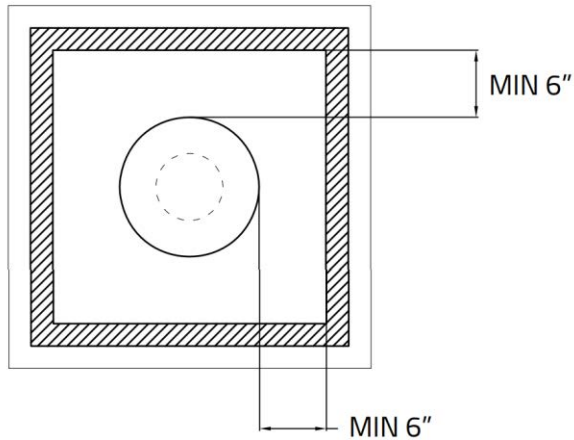

For openings in the shroud, make sure to allow for enough air flow space to release the exhaust gases and allow the vent to operate properly.

The center of the openings must be aligned to the center of the termination cap as displaced in "X" and "Y".

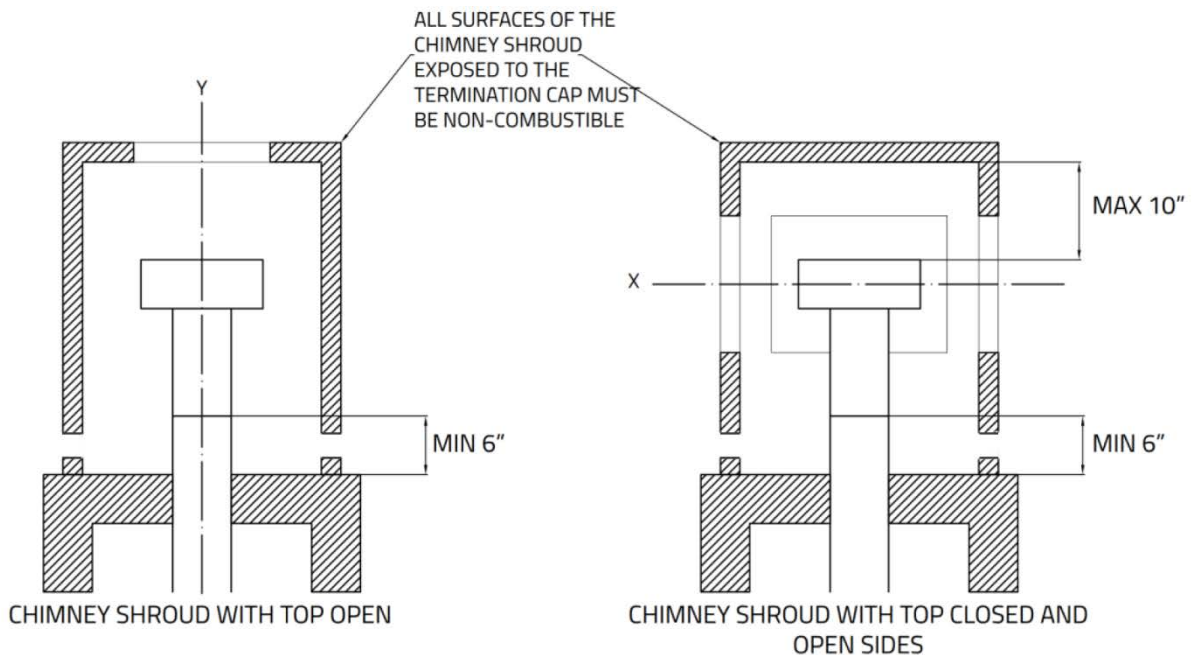

Vent Maintenance

Regular inspection of the venting system by a qualified service technician is recommended every six months. The following maintenance routing is recommended:

1. Inspect for excessive condensation, e.g., water droplets forming in the inner lining, and subsequently dripping from the joints. This can cause corrosion in the system.
 2. Check for corrosion in areas exposed to the elements. Components with rust spots or holes must be immediately replaced.
 3. Ensure that there is no foreign material in the vents. Survey by removing the cap and shining a light down the vent.
 4. If possible, check all joints and pipes to make sure that nothing has been disturbed or loosened.
-

Fireplace Cavity (Chase) Construction

The process of building the chase can be divided into four main phases:

PHASE 1: BUILD BACK AND SIDE WALLS

- Frame the back and side walls. (See “Building Back and Side Walls” section below for details.)
 - If using wood framing or plan on putting a TV or artwork above the fireplace, cover the inside of the walls (the side facing towards the cavity) with 5/8” Type X Drywall or equivalent and level 1 finish.
 - If using metal framing and there is no TV or artwork, inside layer of 5/8” Type X Drywall or equivalent is not required.
- Build the platform (if necessary) to the desired height and install inside fireplace cavity. Platform must be stable and able to bear the full weight of the fireplace. Platform can be constructed out of wood, concrete, metal or any other solid materials. Material does not have to be non-combustible.

PHASE 2: INSTALL FIREPLACE & VENTING, RUN GAS & ELECTRICAL

- Install the fireplace. This can only be completed by an authorized ORTAL dealer (unless otherwise authorized by ORTAL with written approval). See the “Fireplace Installation Instructions” section for details.
- Install pipe/venting. See the “Fireplace Installation Instructions” section for details.
- Move the gas valve & receiver unit to the designated access panel location. If the fireplace will not have an access panel, keep gas valve & receiver unit directly underneath the firebox.
- Run gas and electric to the gas valve & receiver unit location.

PHASE 3: BUILD FRONT WALL

- Build front cavity wall (aka infill panel):
 - For Metal/Non-Combustible Framing:
 - Build the front wall using metal studs.
 - Stand up the front wall and move into place.
 - Secure front wall to the rest of the cavity structure.
 - For Wood/Combustible Framing:
 - Build the front wall using wood studs (leaving room for min. 18” non-combustible/metal insert directly above the fireplace opening).
 - Cover the inside portion of the wall with 5/8” Type X Drywall or equivalent and level 1 finish.
 - Stand up front wall and move into place.
 - Secure front wall to the rest of the cavity structure.
 - Build & install min. 18” non-combustible metal insert (see “Framing Requirements & Diagrams” section for details).
 - Cover the exterior of each wall (sides and front, and back if applicable depending on your design) with 5/8” Type X Drywall or equivalent and level 1 finish.
-

PHASE 4: APPLY FINISHES

- Apply finishes and install accessories. Make sure to follow all clearances as outlined in the “Clearance & Finish Diagrams” section.
- Turn the project over to the customer. See “Turning Project Over to End User” section for details.

Cavity (Chase) Construction Notes

Non-combustible Framing

The wall behind an ORTAL fireplace (either at the back or side of the fireplace) and the ceiling above the unit must be non-combustible construction such as 5/8” Type X Drywall, concrete, brick, concrete masonry units, or plaster on metal framing and lath. Penetrations in the wall or ceiling, such as electrical boxes, must be removed and patched to assure integrity of the non-combustible enclosure.

Combustible Framing

The first 18" (minimum) of framing MUST be non-combustible (steel studs). Existing walls or ceilings built of combustible materials may be used if the wall or ceiling is covered with 5/8” Type X Drywall or its equivalent.

An exception to this rule is when the walls of the chase do not extend all the way to the ceiling and allow a “gap” for heat release. In this scenario, ½” Type X Drywall (or its equivalent) may be used to match the thickness of Type X Drywall used on the ceiling outside the chase.

Floor/Platform

An ORTAL fireplace can be set on wood, concrete, metal and other typical solid floor types. ORTAL fireplaces come with legs that position the unit above the floor or platform on which they are installed. (See unit drawings for height.) To raise an ORTAL fireplace, build a platform to which the unit can be secured. Platform must be stable and able to bear the full weight of the fireplace. Platform can be constructed out of wood, concrete, metal or any other solid materials. Material does not have to be non-combustible. To lower a fireplace, it must be recessed into the floor. The legs cannot be removed, cut or adjusted.

Drywall Chase Interior

Wood framing must be covered with 5/8” Type X Drywall or its equivalent on the inside portion of the cavity.

In remodeling projects, apply a layer of 5/8” Type X Drywall (or its equivalent) over existing material, unless it is certain that the existing surfaces are 5/8” Type X Drywall or another acceptable non-combustible material.

Installing the Fireplace and Venting

The installation of the fireplace and venting can only be completed by an authorized ORTAL dealer unless otherwise authorized by ORTAL via documented approval. ORTAL fireplaces must be installed in accordance with the ORTAL Installation Manual and applicable local and national building codes. Install the direct vent pipe, make gas and power connections, and provide fire stopping or thimble where the direct vent pipe penetrates the wall or ceiling of the chase.

Building the Front Wall

It is recommended to postpone installation of the front wall of the cavity until after the fireplace and pipe have been installed. This will allow access for installing drywall inside the chase, positioning the ORTAL fireplace and direct vent pipe, and making necessary connections.

Install framing in accordance with building codes and project specifications. All studs are placed 16 inches on center, or per local code.

Plan your work carefully, paying attention to:

- Required clearances (see “Clearances & Finish Diagrams” section for details).
- Blocking for securing the fireplace, direct vent pipes, mantles, drywall, etc.
- Access panel for the gas valve and receiver unit (see “Access Panel” section for details).
- Heat release & air intake (see “Heat Release” and “Double Glass Requirements” sections for details).
- Direct vent, direct vent strapping, and penetrations through walls and ceiling.
- Recesses for TV, audio speakers, light fixtures, art work, and other items built into chase (if required).

Take a moment for a final visual inspection of the chase interior. Remove any construction debris that may be inside the chase.

Install conduit, wiring, power outlets, and electrical boxes between framing members with 5/8 Type X or its equivalent on both sides.



Building and structural loads must not bear on the ORTAL fireplace.

Working with Drywall

Cover the metal framing with 5/8” Type X Drywall (or its equivalent) to exterior face of the chase. Exceed these requirements where fire-resistance-rated construction or other methods are required.

5/8” Type X Drywall or its equivalent must comply with ASTM C1396 - Specification for Gypsum Board. Provide Level 1 or better finish, in accordance with GA-214 - Recommended Levels of Gypsum Board Finish.

Do not locate exposed 5/8” Type X Drywall joints directly above the fireplace.

If corner beads and other drywall trim are required, use metal products where non-combustible materials are required. For added Cool Wall effect, cover both the interior and exterior of steel studs (this is absolutely required if framing in wood or installing a TV/artwork above the unit). Use fireplace-specific cement boards such as manufactured by Promat and Skamol for maximum heat protection.

Fireplace Installation Instructions

The following sections describe fireplace components and installation operations.

Selecting a Location

Keep the following factors in mind when selecting a location for the fireplace:

- Minimum clearances to combustible materials must be met.
- Adequate clearances for servicing need to be provided.
- Consider the minimum vent vertical and allowed horizontal lengths and number of bends
- Consider framing and finishing requirements (surrounding framing and materials to be completed after fireplace installation).
- The appliance must be installed on a flat, solid, continuous surface (e.g., wood, metal, or concrete). This may be the sub-floor or a raised platform.

Installation Sequence

Use the following guidelines to help ensure a smooth and error-free installation. The installation sequence is divided into three phases: planning, installation, and startup.

First Trip to Site: Planning Phase

Consult with the contractor and go over all ORTAL requirements:

- Chase and framing requirements.
- Drywall or noncombustible inside the chase.
- Air intake and heat release.
- Access panel size and location.
- Gas and electrical specs and location.
- Venting configuration.
- Finishing details.

Second Trip to Site: Installation Phase

- Confirm the framing and platform are built to spec.
- Confirm gas and electric are in the correct location.
- Confirm access panel location and size.
- Confirm air intake and heat release locations.
- Make sure there is a clear path to carry in the unit.
- Uncrate the unit and set in place.
- Use the shipping bracket for the legs and seismic brackets to level and secure the unit (see note below).
- Cut off ALL the zip ties.
- Move the components to the access panel location. Be mindful of the routing for future service needs.
- Install the venting components per the venting manufacturer's instructions and ORTAL requirements.
- Go over the infill panel requirements and finishing details with the contractor.
- Protect the fireplace and components from damage.

SECURING THE UNIT: Use the supplied seismic brackets and leg shipping brackets to secure and level the fireplace. If necessary, the brackets can be extended with similar steel components. It is crucial to the finishing that the unit is stable, level and plumb. The legs are zero clearance. Wood shims are acceptable.

Third Trip to Site: Startup Phase

- Perform a visual inspection to confirm that all work was completed per ORTAL specifications.
- Confirm that gas and electric are properly connected and live.
- Remove the safety barrier and glass.
- Clean the inside of the unit.
- Confirm operation and remote-control setup.
- Set up the media per ORTAL specifications.
- Remove protective layers and clean glass.
- Install the glass and safety barrier.
- Go over operation of the unit and remote with the homeowner.
- Set up return visit to clean glass after initial burn-off period.

Working with Glass Panels

5mm ceramic glass front and side panels are provided. Contact ORTAL USA for replacement parts if required. 3/16 tempered glass exterior panels can be sourced locally.

Silicone comes pre-applied to any glass-to-glass connections (LS, RS, TS and SC models), on both sides of the glass. Keep the following guidelines in mind when handling silicone and glass panels:

The purpose of the silicone is to create a gasket, not to “glue” the glass panels together. When placing glass panels, ensure that the glass is fully in place and that the silicone is filling the space between the glass panels. Place the front (or center) panel in place first and then slide the side panel into place so that the silicone edge touches the glass edge.

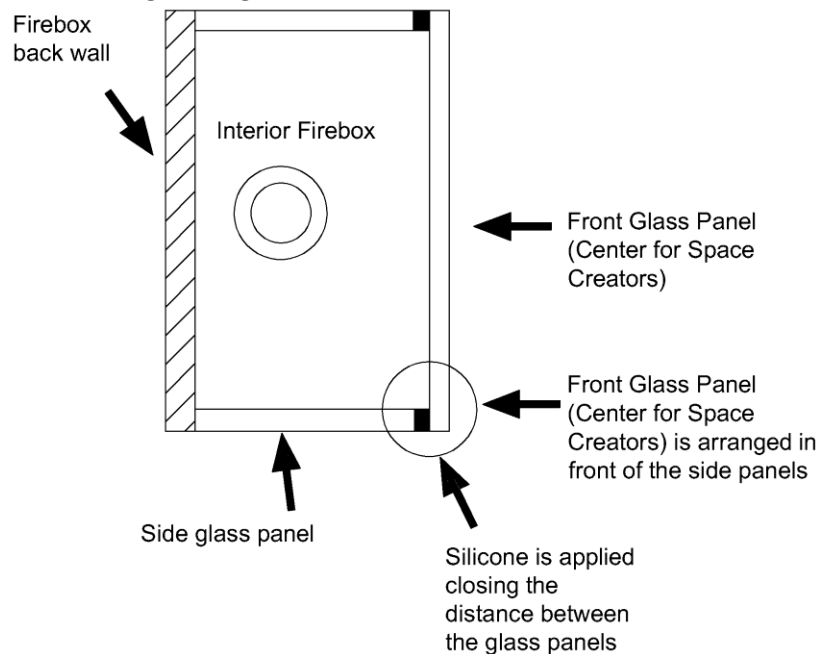











Glass Seal Assembly Diagram

- Re-apply silicone only if the original silicone is damaged (Rutland 500° Clear Silicone is recommended).
- If new silicone is applied, cure time is 24 hours before operation of the fireplace.
- Do not use silicone to seal the glass after it is in place.
- Always use appropriate materials and cleaning agents to clean glass. Ammonia free glass cleaners and/or ceramic glass cleaners are recommended.

Remote Control Setup and Operation

This section provides safety information and instructions for setting up and operating the remote control. The redesigned GV60 handsets G6R-H...FB and G6R-H...FW operate the same as the previous handset G6R-H... Only the symbols on the buttons have changed. See the figure below for the corresponding symbols.

KEY ASSIGNMENTS		
G6R-H...FB(W)		G6R-H...
	=	
	=	
	=	
	=	
	=	

New style Old style

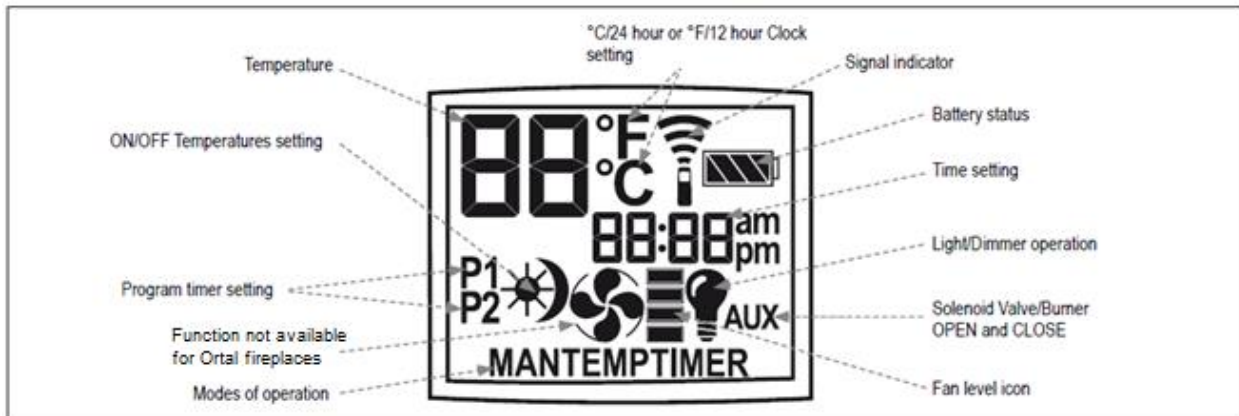

Remote Control Radio Frequency

Radio frequency of the remote control supplied with your appliance is 315 MHz for U.S. and Canada. This device complies with part 15 of the FCC Rules. Operation is subject to the following conditions:

- This device may not cause harmful interference
- This device must accept any interference received, including interference that may cause undesired operation.
- Changes or modifications not expressly approved by the party responsible for compliance could void the user's authority to operate the equipment.



NOTE: Wiring of valve and receiver must be completed before starting ignition. Failure to do so could damage the electronics.

Pairing Remote to Receiver (Setting the Electronics Code)

To make sure your remote can speak to your appliance, follow these guidelines to set the code on the radio frequency handset and pair the remote and receiver. These instructions are taken directly from the electronics manufacturer Mertik Maxitrol:

1. Press and hold the receiver's reset button until you hear two beeps. The first beep is short, and the second beep is long. After the second beep, release the reset button.



2. Within the subsequent 20 seconds, press the small flame button on the handset until you hear two additional short beeps confirming the connection. If you hear one long beep, this indicates the connection has failed or the wiring is incorrect.



NOTE: The connection between remote and receiver only needs to be made once and is not required after changing the batteries in the remote or receiver.

Battery Requirements

Handset:

- 3 x "AAA" (alkaline recommended)
- A low battery indicator is visible on remotes with display.
- Handsets without display: the red LED gets darker.
- Battery replacement is recommended after 1 year.
- The handset may display options that are not available on all fireplaces.

Receiver:

- Batteries are not required for the receiver as an AC adapter is provided with every appliance to plug directly into an outlet.
- Screen units without additional options can run on battery in case of power outage.
 - 4 x 1.5V "AA" (alkaline recommended)
 - Low battery indication: Frequent beeps for 3 seconds when motor turns.
- Units with additional options such as double glass, lighting, and/or power vent *cannot* operate without an AC Adapter.

Battery replacement is recommended at the beginning of each heating season.



NOTE: Only the AC Adapter manufactured by Mertik Maxitrol is compatible for use with ORTAL appliances. Use of other adapters may render the system inoperable.

Operating Instructions

Some options on the remote may not be available on all fireplaces. For complete operating instructions, please refer to the Homeowner's Operation and Maintenance Manual. These operation instructions come directly from the remote manufacturer, Mertik Maxitrol

TO TURN ON APPLIANCE

Remote Control Handset

1. Simultaneously press the power and up arrow buttons until a short beep confirms that the start sequence has begun; release buttons.
2. Continuing beeps confirm the ignition is in process.
3. Once the pilot ignition is confirmed, there is main gas flow.
4. After main burner ignition, the handset will automatically go into manual mode.

Wall Switch

1. Press "ON/OFF" button until a short beep confirms that the start sequence has begun; release button.
2. Continuing beeps confirm the ignition is in process.
3. Once the pilot ignition is confirmed, there is main gas flow.

TO TURN OFF APPLIANCE

Remote Control Handset

1. Press power button.

Wall Switch

1. Press "ON/OFF" button.



Remote ON



Remote OFF



Wall Switch ON/OFF

Interior Design Media

ORTAL offers interior media options such as stones, glass, logs and embers that can be provided with the fireplace unit. This section provides guidelines for safe placement of media.

WARNINGS – INSTALLING AND HANDLING MEDIA

- **DO NOT** install the interior design media until appliance installation is complete, the gas line is connected and tested for leaks, and initial burner operation has been inspected and approved.
- Media materials get very hot and will remain hot up to one hour after gas supply is turned off. Handle media only when materials are cool.
- If media is not installed according to the installation instructions, flame impingement and improper combustion may occur and result in soot and/or excessive production of carbon monoxide (CO). Carbon monoxide is a toxic, colorless, and odorless gas.

 **WARNING** – The appliance is **NOT** designed to burn wood. Any attempt to do so could cause irreparable damage to the appliance and may result in property damage, personal injury and/or loss of life.

Media Placement Guidelines

When installing media, adhere to the following general guidelines:

- Keep the media back from the pilot hood so at least one burner port is open. Otherwise, there will be delayed ignition.



- Do not use the hood to support media. This could cause overheating of the thermocouple.
- Keep the media away from the edges and the glass.
- Do not overfill the media tray. Keep 30% of the tray open to allow for air flow.

Glass Media Placement

- When placing glass media, put only a single layer, and do not pack down. Once the media is placed, go back and move the glass back slightly to open the ports:



Stone Media Placement

- When placing stone media, use the space left by the round shape to leave the ports open.



Log Media Placement

- Place the logs carefully to block as few ports as possible. If a log is placed over a port, block the port with a “coin” to keep the flame from creating soot on the media or to manipulate the look of the flame.

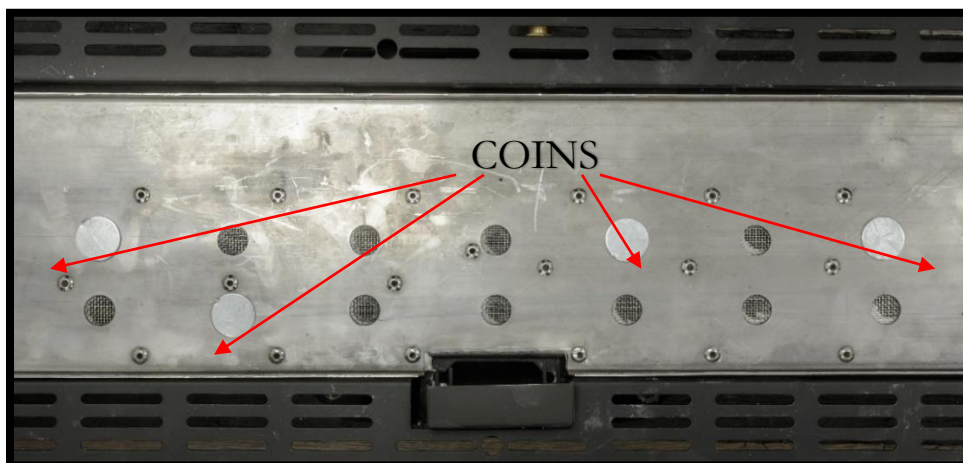



- Block as few ports as possible, and no more than 30% of total ports. Do **NOT** block ports that are next to one another. This will cause delayed ignition.
- When combining both logs and glass, it is recommended to place the logs (and coins if needed) first, and then to spread the glass according to the instructions given above.



Cold Climate Insulation

Seal all cracks around your appliance with noncombustible material wherever cold air could enter the room. It is especially important to insulate outside chase cavity between fastenings, and under the floor on which the appliance rests if the floor is above ground level. Gas line holes and other openings should be caulked or stuffed with un-faced fiberglass insulation.

If the fireplace is being installed on a cement slab, a sheet of plywood or other raised platform can be placed underneath to prevent cold transfer to the fireplace and into the room. It also helps to sheetrock inside surfaces and tape and caulk fire stops for maximum air tightness.

Post-installation Procedures

The following sections present post-installation operations.

Initial Burning Period

Following installation of an ORTAL fireplace, there is a 12-hour minimum burning period. This 12-hour period must include a minimum of 4 hours of continuous burning. During this time, the customer/installer may notice:

- The glass developing a white or “cloudy” film
- An unusual smell

Both the film and the smell are due to the paint on the fireplace metal heating and “burning off”. This is normal. The cloudiness and odor will disappear after the 12-hour period elapses and the installer returns to service the fireplace and complete startup.

Final Inspection Procedure

When the 12-hour burning period is complete, the installer returns and performs the final inspection, which includes:

- Cleaning the glass with a ceramic glass cleaner (otherwise the white film will remain)
- Checking the interior media
- Checking for gas leaks
- Adjusting the restrictor (if necessary)
- Performing an overall check to make sure that everything is working properly

When these activities are complete, initial startup is concluded and the fireplace may be operated by the owner.

Final Checks and Customer Instruction

Before releasing the unit to the customer for use without installer supervision, the installer must ensure that the appliance is burning correctly. In addition, the installer must:

- Review and explain unit operation to customer
- Review and explain safety warnings to customer
- Review and explain to the customer that glass is hot during and after operation
- Review and explain maintenance requirements to the customer
- Review and explain warranty requirements to the customer
- Explain that if any questions or concerns arise, to contact the local ORTAL USA dealer/installer or ORTAL USA directly for support.

Operating Warnings

ORTAL direct vent gas fireplace heaters are sealed combustion, air-circulating gas fireplaces designed for residential applications.

For your safety, please read the following warnings carefully before lighting your fireplace. If you do not follow these instructions exactly, a fire or explosion may result, causing property damage, personal injury or loss of life.

 **WARNING –DO NOT OPERATE YOUR APPLIANCE IF:**

The glass is NOT properly secured in place

- Connection points are not sealed (for appliances with glass-to-glass connections)
- Glass is cracked
- You smell gas
- Any part of the appliance has been under water
- You have any doubt about safe operation of the unit
- If any part has been under water, do not use the appliance. Immediately call a qualified, professional service technician to inspect the appliance and to replace any parts of the control system and any gas controls which have been under water.

Maintenance Instructions

The following sections provide maintenance information, checklists and logs.

General Maintenance: Tips and Warnings

 **WARNING –SERVICING**

- It is recommended that a qualified service technician perform a routine inspection at the beginning of each heating season.
- Turn off the gas and electricity **BEFORE** servicing the fireplace.

 **WARNING –BURNER AND VENT INSPECTIONS**

- Periodic checks should be made of the burner for correct position and condition. Visually check the flame of the burner, making sure that the flames are steady. For any problem, call a qualified service technician.
- The venting system must be inspected before use. Annual inspection by a qualified field technician must be scheduled to ensure the flow of combustion and ventilation air.

 **WARNING –SUBMERGED PARTS**

- Do not use the appliance if any part has been under water, or if you suspect that it may have been under water. Immediately call a qualified, professional service technician to inspect the appliance and to replace any parts of the control system and any gas controls which have been under water.

 **WARNING –HANDLING OF GLASS**

- NEVER operate the appliance without the glass properly secured in place.
- The glass must be removed **ONLY** by an authorized qualified installer.
- The technician should **ONLY** remove the glass with the suction cup supplied by the manufacturer. Lower the glass to rest in a safe place to prevent damage to the glass edges.

 **WARNING –CLEANING THE UNIT**

- ALWAYS turn off the gas valve before cleaning.
- Do NOT clean when hot. Make sure unit has had time to cool prior to cleaning any surface or component, interior or exterior.

- Keep the unit clean by brushing and/or vacuuming at least once a year by a service technician.
- Only service technicians can open the fireplace to clean interior surfaces.
- Clean the glass when it starts to look cloudy. Use a damp cloth for cleaning the appliance and the door.
- Verify correct operation after servicing.
- Maintenance Frequency and Equipment Checklist
- Under normal circumstances, the factory recommendation is to have the unit serviced at least once a year (annual service). Units meeting the following conditions should have more frequent service:
 - Units installed in commercial/public spaces should be serviced every 3 months (quarterly).
 - Units installed in climates near the ocean or in other settings where corrosion buildup is more likely should be serviced every 6 months (semi-annual service)
- Thermocouple Maintenance
 - The thermocouple should be replaced annually or as needed in all commercial installations, and in any residential unit where the fireplace is operated for an average of 10 hours or more per day.
 - For all other installations, the thermocouple should be replaced every three years or as needed.

Warranty Policy

Below is the warranty policy of Ortal Ltd. and Ortal USA, Inc. for Standard products sold and distributed in North America. Warranties may vary for custom models.

THE WARRANTY

The Ortal Ltd. and Ortal USA, Inc. Limited Warranty warrants your Ortal USA gas fireplace (“Product”) to be free from defects in materials and workmanship at the time of manufacture. The Product body and firebox carry the 10 Year Limited Warranty. Ceramic glass carries the 5 Year Limited Warranty against thermal breakage only. After installation, if covered components manufactured by Ortal are found to be defective in materials or workmanship during the Limited Warranty period and while the Product remains at the site of the original installation, Ortal USA will, at its option, repair or replace the covered components. If repair or replacement is not commercially practical, Ortal USA will, at its option, refund the purchase price or wholesale price of the Ortal product, whichever is applicable. Ortal USA will also pay Ortal USA prevailing labor rates, as determined in its sole discretion, incurred in repairing or replacing such components for up to five years. There are exclusions and limitations to this limited warranty as described herein.

COVERAGE COMMENCEMENT DATE

Warranty coverage begins on the date of installation subsequent to the completion and return of the signed warranty card and to Ortal USA’s receipt of payment in full for the Product. In the case of new home construction, warranty begins on the date of first occupancy of the dwelling or six months after the sale of the Product by an independent Ortal USA dealer/distributor, whichever occurs earlier. The warranty shall commence no later than 24 months following the date of product shipment from Ortal or Ortal USA, regardless of the installation or occupancy date.

EXCLUSIONS AND LIMITATIONS

This Limited Warranty applies only if the Product is installed in the United States or Canada by an approved Ortal dealer/distributor, and only if installed, operated and maintained in accordance with the printed instructions accompanying the Product and in compliance with all applicable installation and building codes and good trade practices. Printed instructions include those which direct the installer and/or owner to refer to the product information, diagrams, and operation and maintenance manuals

available on Ortal USA's website, www.ortalheat.com. These can also be requested in digital format direct from Ortal USA's office(s).

This warranty is non-transferable and extends to the original owner only. The Product must be purchased through a listed supplier of Ortal USA and proof of purchase must be provided. The Product body and firebox carry the 10 Year Limited Warranty from the date of installation. Vent components, trim components and paint are excluded from this Limited Warranty. The following components are part of the Limited Warranty and are warranted as follows:

- **Burner:** Repair or replacement for two years from the date of installation
- **Gas Components (including the valve):** Repair or replacement for one year from the date of installation
- **Gaskets:** Repair or replacement for one year from the date of installation
- **Interior Decorative Media:** Replacement for one year from the date of installation against thermal breakage only
- **Optional Blowers and Remote Controls:** Repair or replacement for one year from the date of installation. Water damage and batteries are entirely excluded.
- **Ceramic Glass:** Replacement for five years from the date of installation against thermal breakage only.
- **Labor Coverage:** Prevailing Ortal USA labor rates apply for the warranty period of components. Labor coverage is for actual repair and/or replacement of components. Troubleshooting is excluded.

Parts not otherwise listed carry a 90-day warranty from the date of installation. Whenever practicable, Ortal USA will provide replacement parts, if available, for a period of 5 years from the last date of manufacture of the Product.

Ortal USA will not be responsible for: (a) damages caused by normal wear and tear, accident, riot, fire, flood, climate and weather corrosion or natural disaster; (b) damages caused by abuse, negligence, misuse, or unauthorized alternation or repair of the Product affecting its stability or performance. The Product must be subjected to normal use. The Product is designed to burn on either natural or propane gas only as determined by the customer when originally purchased or changed after installation by an authorized installer only. Burning conventional fuels such as wood, coal or any other solid fuel will cause damage to the Product, will produce excessive temperatures and could result in a fire hazard.); (c) damages caused by failing to provide proper maintenance and service in accordance with the instructions provided with the Product; (d) damages, repairs or inefficiency resulting from faulty installation or application of the Product.

Ortal USA is not responsible for inadequate fireplace system draft caused by air conditioning and heating systems, mechanical ventilation systems, or general construction conditions which may generate negative pressure in the room in which the appliance is installed. Additionally, Ortal USA assumes no responsibility for drafting conditions caused by venting configurations, adjoining trees or buildings, adverse wind conditions or unusual environmental factors and conditions that affect the operation of the unit.

This Limited Warranty covers only parts and labor as provided herein. In no case shall Ortal USA be responsible for materials, components or construction, which are not manufactured or supplied by Ortal USA or for the labor necessary to install, repair or remove such materials, components or construction. Additional utility bills incurred due to any malfunction or defect in equipment are not covered by this warranty. All replacement or repair components will be shipped F.O.B. from the nearest stocking Ortal USA warehouse.

LIMITATION ON LIABILITY

It is expressly agreed and understood that Ortal USA's sole obligation and the purchaser's exclusive remedy under this warranty, under any other warranty, expressed or implied, or in contract, tort or otherwise, shall be limited to replacement, repair, or refund, as specified herein.

In no event shall Ortal USA be liable for any incidental or consequential damages caused by defects in the Product, whether such damage occurs or is discovered before or after repair or replacement, and whether such damage is caused by Ortal USA's negligence. Ortal USA has not made and does not make any representation or warranty of fitness for a particular use or purpose, and there is no implied condition of fitness for a particular use or purpose.

Ortal USA makes no expressed warranties except as stated in the Limited Warranty. The duration of any implied warranty is limited to the duration of this expressed warranty.

No one is authorized to change this Limited Warranty or to create for Ortal USA any other obligation or liability in connection with the Product. Some states and provinces do not allow the exclusion or limitation of incidental or consequential damages, so the above limitations or exclusions may not apply to you. The provisions of the Limited Warranty are in addition to and not a modification of or subtraction from any statutory warranties and other rights and remedies provided by law.

INVESTIGATION OF CLAIMS AGAINST WARRANTY

Ortal USA reserves the right to investigate any and all claims against this Limited Warranty and to decide, in its sole discretion, upon the method of settlement.

To receive the benefits and advantages described in this Limited Warranty, the appliance must be installed and repaired by either a qualified or authorized Ortal USA installation technician. Refer to your dealer/distributor sales agreement for requirements. Contact Ortal USA at the address provided herein to obtain a listing of approved dealers/distributors and certified/authorized installer companies. **Ortal USA shall in no event be responsible for any warranty work done by an installer that is not approved without first obtaining Ortal USA's prior written consent.**

HOW TO REGISTER A CLAIM AGAINST WARRANTY

In order for any claim under this warranty to be valid, you must contact the Ortal USA dealer/distributor from which you purchased the product. If you cannot locate the dealer/distributor, then you must notify Ortal USA in writing. Submission of a completed warranty claim is the preferred method of warranty claim notification. Ortal USA must be notified of the claimed defect in writing within 90 days of the date of failure. Notices should be directed to the Ortal USA Warranty Department at 8421 Canoga Avenue, Canoga Park, CA 91304, or visit our website at www.ortalheat.com.

Printed in U.S.A. © 2017 Ortal USA, Inc.

Ortal USA
8421 Canoga Avenue
Canoga Park, CA 91304

Manufacturer Contact Information

ORTAL USA, Inc.
8421 Canoga Avenue
Canoga Park, CA 91034
Phone: (818) 238-7000
Fax: (818) 678-0541
Email: info@ortalheat.com
Website: www.ortalheat.com

**For all service/trouble shooting issues, please
contact your Ortal dealer.**

Sample Product Certification Labels

The following figures show sample certification labels for various product series. This label is found on a metal plate that should be located near the access panel area.

DEALERS/INSTALLERS: You **MUST** leave your appliance's label with the appliance. Instruct the owner before handing over the appliance where this label can be found in their installation.

OWNERS: Make sure your installer leaves your appliance's label with the appliance in an area that is easily accessible for you (preferably in an area you can see when you open your access panel). This information is required for servicing and receiving replacement parts.

Do Not Remove This Label
Ne pas retirer cette étiquette









YOUR LIFE. YOUR FIRE

For use only with vent, glass and interior design media certified and approved for use with the appliance. Not for use with solid fuel. For use with barriers certified for this appliance only.
 Utilisez uniquement avec des conduits, des panneaux vitrés et des accessoires décoratifs intérieurs homologués et approuvés pour une utilisation avec cet appareil. Pas pour l'usage avec le combustible solide. Pour une utilisation avec des barrières certifiées pour cet appareil uniquement.

Approved by / Homologué par:  no. **2358468**

S - Single Orifice Burner/Brûleur d'orifice singulier
 D - Double Orifice Burner/Double brûleur d'Orifice

Check one (check space to the right of the model name) / Cochez un choix (cochez à droite du nom du modèle) :

Clear 110 / RS / LS / TS / Tunnel <input type="checkbox"/>	Island 130 <input type="checkbox"/>
Stand Alone 110 <input type="checkbox"/>	Clear 130 / RS / LS / TS / Tunnel / Top <input type="checkbox"/>
Clear 110 H / Tunnel <input type="checkbox"/>	Space Creator 120 / Mini / Medium <input type="checkbox"/>
Clear 110H / RS / LS / TS <input type="checkbox"/>	Clear 130H / RS / LS / TS <input type="checkbox"/>

Serial No. / N° de série: _____

Manufacturer / Fabricant :
 ORTAL Heating Systems Ltd.
 Ind. Zone B Neve Neeman, Hod Hasharon
 ISRAEL
 Tel: 011 972 9 7402828
 Fax: 011 972 9 7402687

Tested To / Examiné À: ANSI Z21.88/ CSA 2.93-2016
 Electrical rating / Estimation Électrique: 110 volt /60 Hz/ less than 5A
 Altitude rating / Estimation d'altitude: 0-4500 ft. / 0-1370 m.

	S	S	D	D
Fuel Type / Type de combustible:	<input type="checkbox"/> NG	<input type="checkbox"/> PROPANE	<input type="checkbox"/> NG	<input type="checkbox"/> PROPANE
Max Input / Débit max. (BTU/HR):	37,167	28,541	42,185	33,400
Min Input / Débit min. (BTU/HR):	22,798	22,951	28,878	26,837
Orifice Size / Taille de l'orifice:	1,200	260	650+650	180+180
Gas Inlet Pressure (W.C.) inches / Pression d'entrée de gaz (CE) pouces:	7.0	11.0	7.0	11.0
Gas manifold Pressure (W.C.) inches / Pression d'alimentation (CE) pouces:	5.0	10.8	5.6	10.8

Clearances to Combustibles / Espacement par rapport aux matériaux inflammables:
 Sides / Côtés: 2"
 Back / Arrière: 2"
 In front of Glass / Devant le panneau vitré: 40"

Also adhere to clearance diagrams and instructions included in the ORTAL manual.
 Adhérer également aux schémas d'espacement et des instructions figurant dans le manuel ORTAL.



© Ortal 2018
Rev. 1.0 September 2018

Ortal USA
8421 Canoga Ave Canoga Park, CA 91304
T: (818)238-7000 | F: (818)678-0541
info@ortalheat.com | www.ortalheat.com