

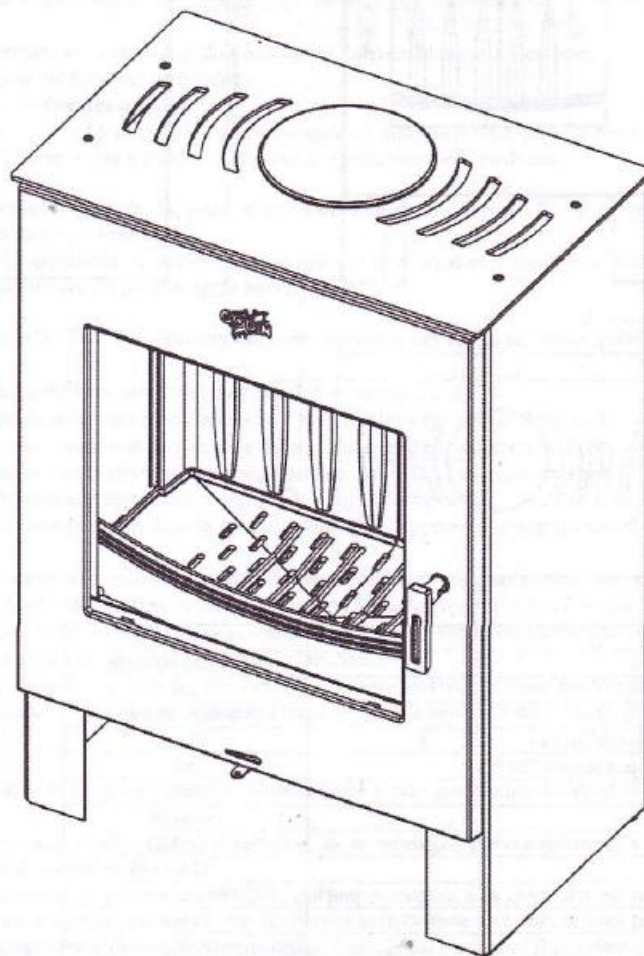

Chevannes  
Ref: 364120



This heater has been designed and manufactured in France. It is important to read this instruction manual completely, before using the heater. It is recommended to keep this manual, even after installation of the unit. This unit has been tested according to the European norms NF EN 13240.

**Technical characteristics:**

**Linedrawing:**

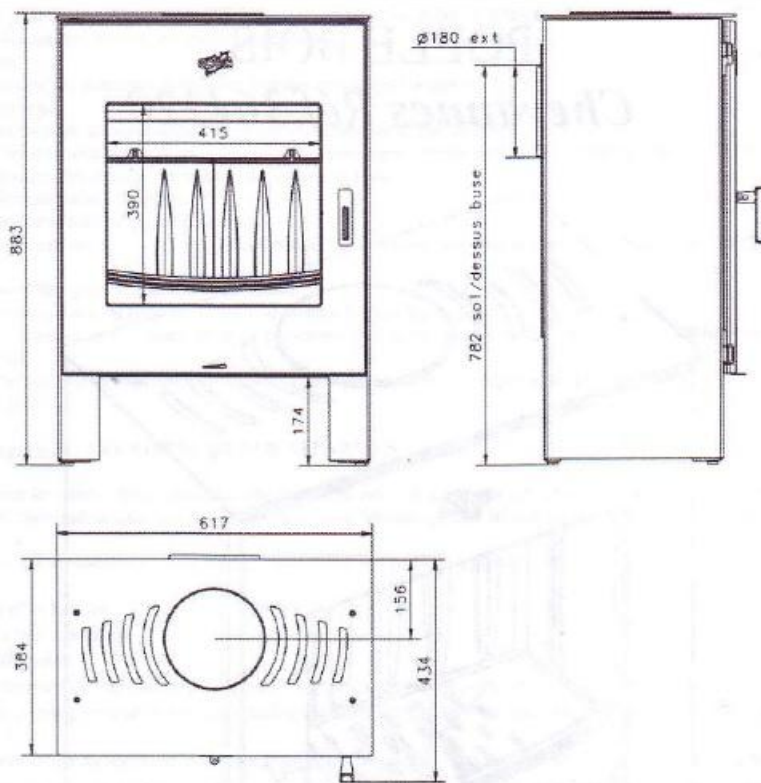

Unit dimensions (mm)	883 x 617 x 384 (height x width x depth)
Fire box dimensions (mm)	350 x 570 x 250 (height x width x depth)
Flue Diameter	180 mm
Flue outlet	Top or rear
Recommended fuel	Wood
Log size loading from the front:	50cm
Panoramic glass resistant to 750 deg C	Yes
Cast iron firebox	Yes
Air Regulation	Yes, manual
Weight	135 kg
Normal kW Output	13 kW

Heating volume	200 - 500 m <sup>3</sup>
Wood consumption at normal rate	4.7kg per hour
Average fume temperature	382 degC
Minimum distances to combustible materials	50cm rear, 50cm sides, 150cm front

We thank you for purchasing a GODIN fireplace.

This appliance was designed and thoroughly tested in order to ensure total satisfaction to our customers. Yet an appropriate installation will be necessary, and an appropriate flue outlet connection to a chimney, which must guarantee sufficient draught flow capacity, this is of the utmost importance. It is of course preferable that this appliance be installed by an installation professional, which knows of all relevant codes of practice and safety regulations and can guarantee flawless installation.

**WARNING:** most values indicated in this instruction manual (safety distances, flue pipe diameter, draught etc) are directly drawn from French regulation, standards and codes of practice. Imperial unit conversions of all figures are given for the sole purpose of general guidance. Particular care should be given to national or local manufacturing standards and safety or installation regulations.

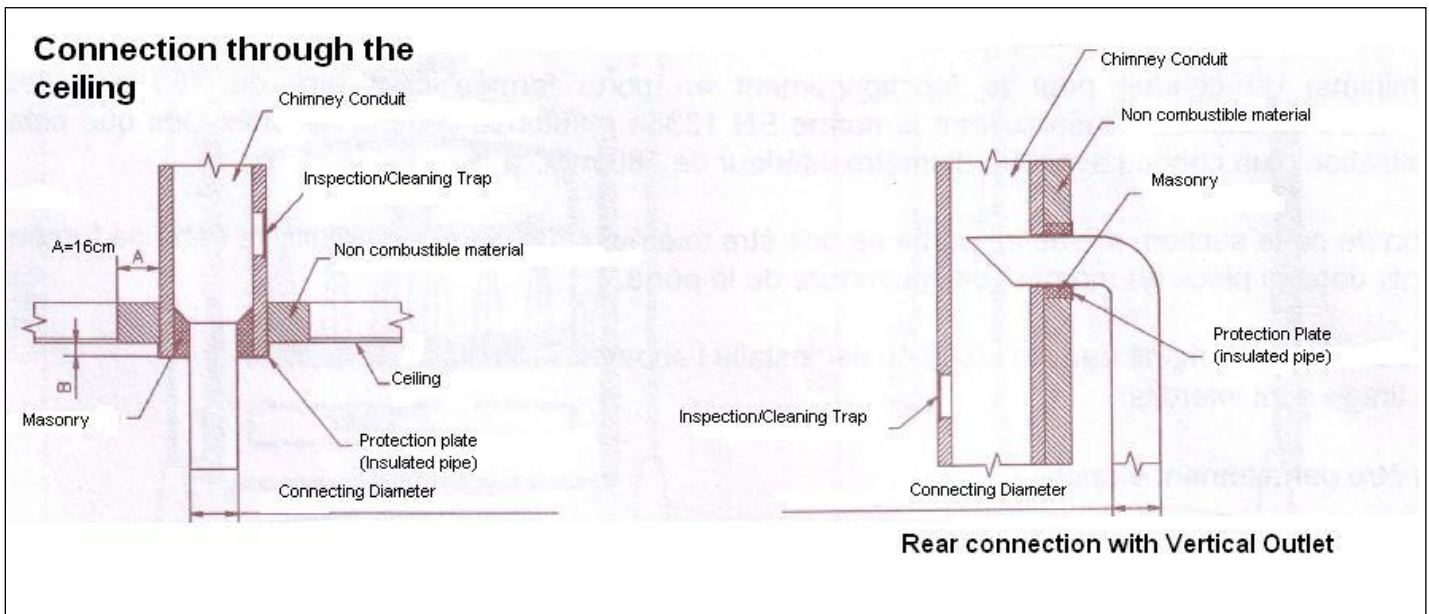

## **GENERAL PRINCIPLES OF CONNECTION FOR REAR AND TOP FLUE OUTLETS (WHERE POSSIBLE)**

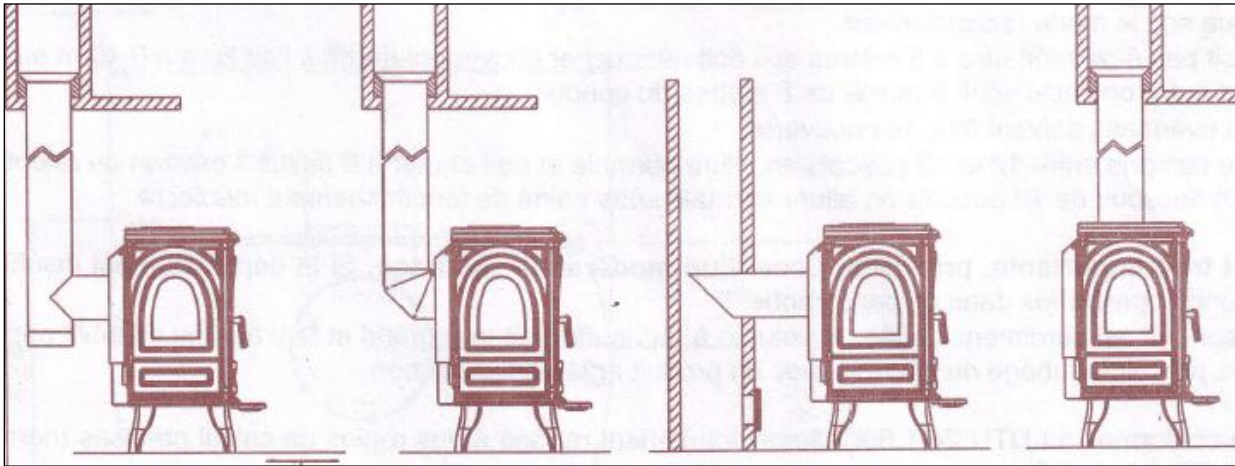

### **Instructions for the installer:**

- Always respect the rules in force of the country where the unit is being installed.
- Make sure the chimney conduit is of good quality. The quality of the chimney conduit will determine the end result.
- It is essential to check that the room in which the appliance is installed is sufficiently ventilated to provide adequate air supply.
- The majority of problems experienced during the operation of the unit are related to an adjustment in the specified chimney conduit. We cannot emphasize this point enough.
- A comparison cannot be made with previous unit's results where the air supply is different.
- An efficient chimney must be built with materials, which have poor heating conductive capacity.
- The minimum cross section of the chimney for a fireplace working with the doors shut is 2.5dm<sup>2</sup> (39sq.in), which corresponds to 180mm (7.09in) diameter (according to French regulations). A flue pipe conduit of 150mm can be used and it is recommended that the height of the flue is not less than 5 metres.
- In no case can this section be reduced, otherwise its flow capacity shall be reduced, and it would cause smoke to spread into the room when the fireplace's door is open.
- The chimney must be perfectly airtight.
- The chimney must only vent one fireplace.
- It must suitably emerge into free air at least 0.40m (15 in.) above the rooftop or any other obstacle situated within a distance of 8 meters (27 feet) from the chimney.
- The height of the chimney deviation must be very open angled.

- The draught must range between 12 and 15 pascals. When burning normally and can drop to 5 pascals when operating at a slow rate. When burning normally, if the draught drops below 12 pascals the unit may function incorrectly (poorly).
- If the cross section of the fireplace is too large, the volume to be heated is too big and the draught won't be able to reach satisfactory levels. In such cases, the chimney shall require internal piping with tubes adapted to wood fires. The pipes diameter should in no case be inferior to 153mm.
- Other units and extractors operating in the same area can generate draught disturbances.
- Never obstruct the heater air intake.
- These appliances are not to be connected to multiple conduits.
- If the spigot is assembled at the rear of the unit, it can be connected directly to the chimney with a horizontal flue.
- It is recommended that an air tight cleaning trap is provided for approximately 50cm below the flue outlet at the rear of the heater. This would make cleaning and serving of the flue/heater easier.
- Installation by a qualified installer is recommended. All material specifications and local rules should be respected.
- Lastly, before connecting the fireplace to its chimney, make sure that the chimney or pipe is perfectly clean. If necessary have the chimney cleaned.

**Important:**

The flue pipes gets hot, make sure that they are away from any combustible materials. If the floor is made of combustible material, it will be necessary to protect the floor with an insulated plate made of non-flammable material. The protection must extend at least 40cm beyond the unit.

Use flue pipes of the stipulated diameter and preferably enamel, as they are less corrosive. The rear wall should not be made of flammable materials. It would be necessary to protect the wall accordingly. The wall on the left and right hand side need to be a minimum of 50cm from the unit, and made of non flammable materials.

The ceiling needs to be at least 80cm above the unit.

Please keep all children, animals and furniture at a sufficient distance way from the fireplace to avoid accidents.

**Connection to the chimney:**

The connection to the chimney conduit to be done preferably with an enamel flue of 153 diameter.

**General information:**

- When operating the unit, do not open the door by hand, use the operating tool or the glove for operation.
- While the heater is burning, keep the door closed.
- Load the unit from the front door.
- The regulation of the combustion is done by sliding the air control at the base of the door from left to right (closed and open). When lighting the fire, the air control would be fully open and during normal operation, it would be in the middle – varying from house to house.
- For normal functioning 3 to 8 logs of 6cm diameter could be used on a bed of coals.

- For a slow burn, one can use fewer logs but of a thicker diameter: 13 to 15cm diameter on a bed of coals. It is always possible to add more logs to prolong the period of combustion of the heater.
- The operation of the fireplace depends on the kind of wood and the dryness of the wood.
- Do not load higher than 25cm.

**Air slide control diagram:**

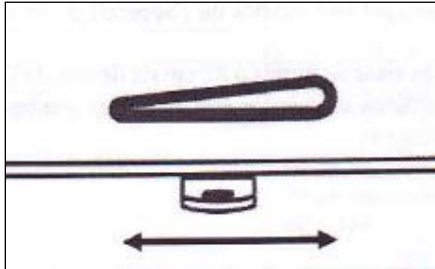

**How to use the unit:**

- Always follow the instructions.
- During the first lighting of your heater use small loads of wood to verify that the unit is functioning properly.
- Gradually increase the amount of logs used over the first few days.
- Never use the unit as an incinerator.
- Use only the recommended fuel. (Dry wood +/- 2 yrs old)
- Do not use the heater if the glass is broken or cracked. Proceed with glass replacement before re-lighting. It is recommended to regularly ensure that the glass retaining clips are not too tight, as this can cause undue stress on the glass when it expands and contracts.
- After a long period in which the unit has not been used, make sure that there are no obstructions in the chimney before lighting.

**Loading – important advice:**

When loading the unit make sure that the fire is burning on low. Do not open the door of the unit if running the heater on high, or if large flames are visible. If opening the door when the flames are visibly high, there is a risk they could leap outside the fire cavity.

Always open the door gently, allowing the draught to stabilize and to avoid down draught.

**Lighting and regulation:**

Use the unit on low fire for the first 2 or 3 days to allow the parts of the unit to expand naturally.

The handles on the unit do get hot during operation, please use the operating tool provided.

Do not worry if during the first lighting fumes are emitted from the unit, this is due to oils used during manufacturing and the curing of paint. The smell of fumes will dissipate after the unit had been used a few times.

- To light the unit – open the door and insert smaller pieces of wood – light the unit – fill slowly and moderately, while leaving the air intake completely open.
- To assist with the initial lighting of the unit, it is possible to leave the door slightly open for a few minutes.
- Once the fire is well lit, load the necessary amount of wood and adjust the air intake accordingly.

**Importance of fuel:**

The unit must provide complete satisfaction; however any heater can only give of the amount of energy contained in the fuel used.

If you feel the unit is not functioning well, then:

- Either there is insufficient burning fuel or the burning fuel does not possess sufficient energy.
- Burn only dry wood that is +/- 2 yrs old. (36 months will be even better)
- In principle, all wood has the same calorific value for the same weight.
- Harder wood is better as it is denser and often less humid.
- The humidity contained in the wood alternates from 15% for dry wood and up to 50% for wet wood. You will require lots of energy to evaporate water.
- The disposable energy for heating will be 4.16 Wh per kg of dry wood. For wood with 50% humidity this reading would drop to 1.73 Wh.
- The use of wet wood will also create condensation in the chimney and will cause the chimney to clog up faster, which may cause chimney fires.

**Removal of ashes:**

Removal of ashes at least every 2 to 3 days after using the unit. Please take care and use the glove and operating tool supplied when moving the ash tray – it may be very hot. Never let the ashes build up in the ash pan or touch the grate, the latter will result in rapid deterioration.

**Cleaning:**

Have your chimney swept annually. Check the condition of the unit and replace worn parts necessary. Please note the build up of soot deposit is a fire hazard, it is important to monitor the use of the unit.

It is possible to maintain the chimney with GODIN net ref 0008 chimney cleaner, however it is still important to have the annual chimney sweep. Check the appliance and make sure the door seals are in a good state. Replace if necessary.

Clean the unit inside, including the fume passages. Clean the glass with GODIN net ref: 0009.

**Maintenance:**

Have your unit checked annually by a qualified person. Never clean the glass of the unit if the unit is still hot. Ensure that any air intakes and your chimney are always clear. The unit is made of cast iron and needs to be polished (graphite paste) during the off season. This also applies to the interior of the unit. When not in use oxidation may cause the cast iron parts to tarnish after a period of time. Care and maintenance of your heater is even more important if it is installed in a home which is rarely occupied (holiday home).

**Replacement of parts:**

If after many years the replacing of parts becomes necessary, contact your supplier or any qualified professional GODIN agent. Provide the model number on the plaques situated at the rear of the unit or on your guarantee card. Please keep your guarantee card even after the guarantee period has expired. The appointed GODIN agent will hold the nomenclatures and all the technical documentation relating to our products, he will then be able to supply all the replacement parts and to carry out the necessary repairs.

Never use spare parts that do not originate from the GODIN factory. Never try to modify the heater without authorization.

**Responsibility:**

We would like to remind the user that the manufacturer's responsibility is restricted to the products it produces. The installation and commissioning of the unit is the responsibility of the installer who must follow the rules and regulations in force as outlined in the manual

So as to constantly improve the quality of our products, the GODIN CO. reserves all rights to modify their appliances without notice.

**Fitting the deflector plate:**

When fitting the deflector plate the following steps need to be followed:

1. Insert the deflector vertically through the front of the unit and lift it into position.
2. Place the deflector as shown below.
  - a. The rear of the plate seats on the cast iron ledge on the rear firebox panel.
  - b. The front of the deflector rests on the panel at the top of the inside of the door.

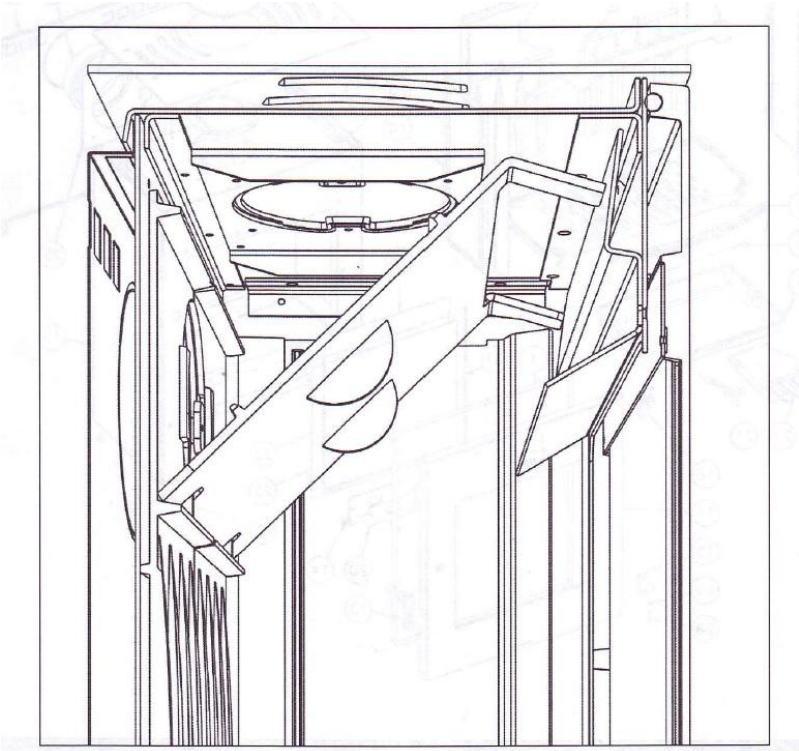



Parts blow up and list:

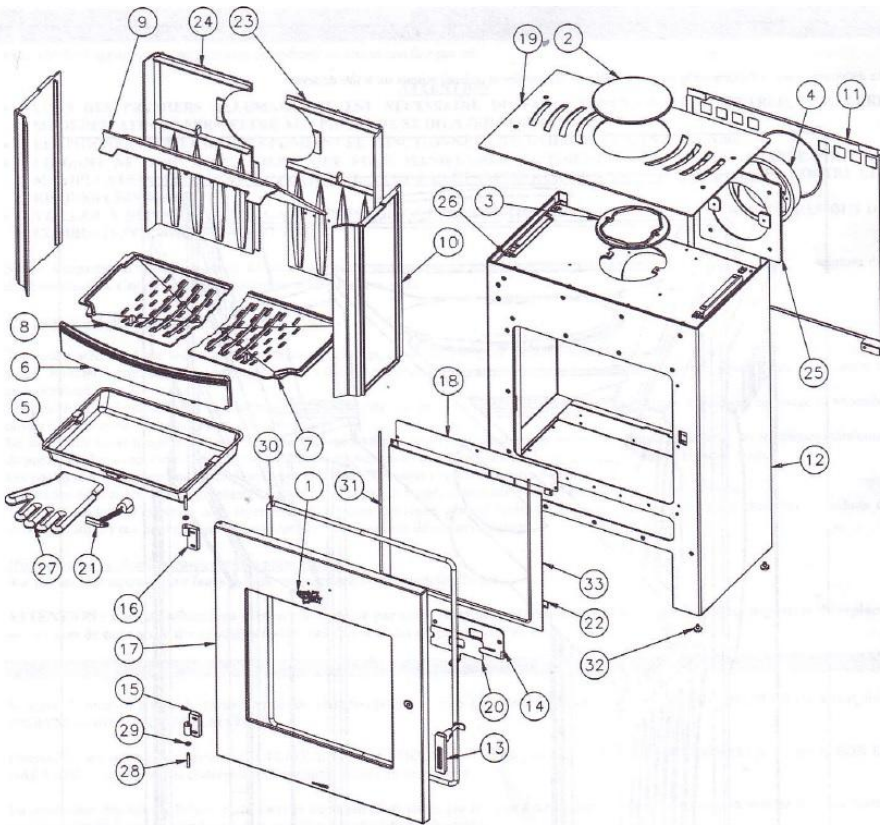

N°	Nb	Désignation	Codification
1	1	Ecusson	1 8501 034400 021
2	1	Obturbateur de dessus	1 1154 3147 01
3	1	Trappe de nettoyage	2 4230 3147 01
4	1	Buse Ø180mm extérieur	2 4312 3152 01
5	1	Tiroir cendres	1 3315 3260 96
6	1	Chenet	1 0306 362101 000
7	1	Support foyer droit	2 0368 362101 001
8	1	Support foyer gauche	2 0369 362101 001
9	1	Défecteur	1 0131 364101 000
10	2	Plaque foyer	1 0164 364101 001
11	1	Plaque protection	1 2420 364101 000
12	1	Corps	1 2507 364120 098
13	1	Poignée porte	1 2839 364120 098
14	1	Conduit air	1 3909 364120 053
15	1	Gond inférieur	1 2933 364120 053
16	1	Gond supérieur	1 2932 364120 053
17	1	Porte chargement	1 2831 364120 053

N°	Nb	Désignation	Codification
18	1	Conduit supérieur air	1 4173 364120 000
19	1	Dessus	1 1101 364120 053
20	1	Volet réglage air	1 4137 364120 053
21	1	Clé à crochet	1 4101 3720 00
22	4	Fixe vitre	1 2071 660101 018
23	1	Plaque foyer droite	2 0162 660108 001
24	1	Plaque foyer gauche	2 0163 660108 001
25	1	Siège buse	1 4322 660108 053
26	4	Ecrou rapid nut M5	00001304496
27	1	Gant	00001307770
28	2	Goupille cannelée 6x40	00001305127
29	2	Ressort rs6 Starlock	00001307254
30	1	Tresse Ø11.5 lg 3000mm	00001305426
31	1	Tresse Ø5 autocollant lg 1400mm	00001304860
32	4	Vérin Ø20 M6 lg 9mm	00001307127
33	1	Verre réfractaire 410x435xep4	00001307564

## **WARRANTY CONDITIONS**

Any warranty is subject to: correct installation, use and maintenance of the unit.

All our appliances have a 2 year guarantee (except inserts running with wood – closed fireboxes running with wood) against any defect starting on the date of purchase. This guarantee is subject to the inspection of the installation, use and maintenance conditions described in the instruction manual supplied with the appliance.

**Parts that are in direct contact with high temperatures** and that could undergo distortions caused by wear and tear **are guaranteed for 1 year**. This includes:

1. Decorative panels, side panels, grills, front hearth floors, grates.
2. Guide plates, baffles, valves, ash pits, air channels and fire-bricks.
3. Articulation mechanisms (Door hinges and handles etc.)
4. Fans , thermostats for overheating of appliances equipped with blast engine
5. Temperature control elements, oven thermostats, and for fan heated gas/electric cookers
6. Burners, catalysers, burner rings for fuel appliances
7. Boilers for central heating and cooking systems for wood/coal.

Our appliances have been specially designed to facilitate replacing of these parts.

**Some parts have a longer guarantee:**

3 years for cast iron or steel heating body of our boilers for central heating.

**Wood-burning Inserts and closed fireboxes running with wood, have a 5 year warranty (only the heating body, parts in direct contact with high temperatures and undergoing wear and tear, described above have 1 year guarantee.)**

Only the parts/s that are deemed to have failed will be covered by the warranty. Any indemnity, compensatory damage, cost of labour and transportation is not included.

In cases the repair or replacement reveals to be too expensive compared to the price of the appliance, the decision to replace or to repair the appliance is to be taken by Godin after sales service only.

**Parts not covered by warranty:**

1. GLASS – ceramic glass can withstand temperatures of up to 750°C. The glass can only break because of a mechanical shock while using or handling the appliance. (it is important to always ensure that any glass retaining clips or brackets are not over tightened).
2. Glass seals and ceramic rope seals are considered wear and tear items.

**The following will invalidate any warranty:**

1. Damage caused by burning fuels other than those for which the unit is intended.
2. Any defect or deterioration caused by a fall, shock, negligence or lack of supervision and maintenance.
3. Deterioration of parts caused by abnormal conditions (back draft, dampness, storm effects, pressure and depression of non conform, temperature shock etc).
4. Abnormal usage of the unit (using a unit with the door open, running it on maximum for extended periods) or abnormal usage of the appliance in conditions that are different from the conditions in our manual for which it has been designed, for example non observation of our technical manuals (wrong electric connection, running an empty boiler etc)
5. Any defect, deterioration or accident caused by fall, shock, negligence, lack of the buyer's supervision or maintenance.
6. Any modifications or transformations made to the unit and non-compliance with installation norms.

Godin SA will not be responsible for any installation, assembly, dismantling costs and consequential removal of the appliance.

Consequently Godin SA, cannot be held responsible for any materials loss or human accidents, being a result of incorrect installation non – observing the legal provisions and regulations (for example, lack of ground connection, incorrect draft of the chimney etc...)

In order to constantly improve our products, we reserve the right to modify our appliances without prior notice. All the dimensions and specifications give are subject to variation according to technical requirements.

In case of a problem occurred during your guarantee period, please contact your retailer providing him with a copy of your bill and guarantee containing the appliances product codes, the retailers stamp, the date of the appliance installation.